

Dew Point Mirror 473



**Operation and
Maintenance Manual**
V5.0

Warranty

MBW Calibration AG. (MBW) guarantees that its products are manufactured to the highest quality of material and workmanship specifications. MBW guarantees the reliability of its products for a period of 24 months from the date of initial shipment when operated in normal use and within the specified design limitations. Under this Warranty, MBW will, at its discretion, repair or replace any component that upon examination by MBW or its duly authorized representatives proves to be defective during the warranty period provided the system is returned to the factory for inspection and repair shipping pre-paid. Improper or unauthorized maintenance, storage, repair, or alteration of any kind by personnel other than MBW or its duly authorized representatives may void all warranties. Warranty may also be voided for misuse, neglect, accident, corrosion, and improper installation. This Warranty is exclusive and in lieu of any and all other warranties of merchantability, fitness for a particular purpose, or any other warranty, expressed or implied, and all other liabilities and obligations on the part of MBW. MBW will not be liable for any other claims or damages, either direct, indirect, or consequential arising out of the use of its products.

Original manuals are supplied in English and German. Translations in other languages are available, but in the event of any discrepancy, the German or English versions will be considered as the official version.

Subject to change without notice.

For the latest version of this manual please visit our website.

Copyright © 2018

2018-04-30

MBW Calibration AG
Seminarstrasse 55/57
CH-5430 Wettingen / Switzerland
+41 56 437 28 30 phone
+41 56 437 28 40 fax
sales@mbw.ch

www.mbw.ch

Table of Contents

WARRANTY	I
TABLE OF CONTENTS	III
1 SAFETY INSTRUCTIONS	1
2 KEY FEATURES	3
3 QUICK START	5
3.1 Unpacking.....	5
3.2 Installing the Measuring Heads	6
3.3 Starting your 473	7
3.4 Dew Point Measurement	7
4 GET TO KNOW YOUR 473	9
4.1 Front Panel	9
4.2 Touch Screen	12
4.3 Back Panel	13
4.4 Measuring Heads	18
4.5 Carrying Handle.....	23
5 SYSTEM CONFIGURATION	25
5.1 The Menu	25
5.2 Selection of indicated Parameters.....	26
5.3 Selection of Numeric or Graphic Data Display	27
5.4 Control Setup.....	30
5.5 Selection of Units.....	35
5.6 Selection of Color	36
5.7 Configuration of Optional Analog Outputs.....	37
5.8 Diagnostic Functions	39
6 SET UP AND OPERATION	43
6.1 Measurement Set Up.....	43
6.2 External Temperature.....	44
6.3 Application Integration	45

7	REMOTE COMMUNICATION	49
7.1	Hardware Connection and Cabling.....	49
7.2	Communication Settings.....	50
7.3	Command Syntax	50
7.4	Command Reference.....	52
8	MAINTENANCE	55
8.1	Calibrate the Touch Screen	55
8.2	Mirror Cleaning	56
8.3	Exterior Cleaning	57
8.4	Peltier Cooling Test	58
8.5	Periodic Maintenance Checks	58
9	ERROR MESSAGES	59
9.1	Reversible Error Messages	59
9.2	Irreversible Error Messages.....	59
9.3	Fan failure SHX	60
10	SPECIFICATIONS	61
11	DRAWINGS.....	63
11.1	Display Unit.....	63
11.2	Measuring Heads.....	65
12	FAQ'S	69

1 Safety Instructions



- Disconnect power supply before opening the instrument housing or connecting / disconnecting sensors.
- Measuring head may get hot during operation.

ATTENTION!
Use instrument only with
SH3 measuring head!

Instruments built for the SH3 measuring head supply more power through the measuring head cable. Therefore you must not connect an SH2 or RP2 measuring head to these display units, as it will damage the measuring heads.

2 Key Features

Precise and Stable Humidity Measurement

With the 473 Dew Point Mirror you are able to perform precise dew point measurements as well as measurements of other parameters such as relative humidity. The humidity measurement of the 473 is based on chilled mirror condensation technology which provides highly precise, stable and repeatable results.

Remote Measuring Heads with Temperature Probe

The 473 features remote cable mounted measuring head options, the RP2, SH2, SH3 and SHX. They are designed for direct placement into applications. Measuring heads are available with a PRT for precise temperature measurement and for the calculation of relative humidity.

Optional Pressure Measurement

Optionally, the 473 can be ordered with internal pressure measurement capability. This enables the user to measure barometric pressure or pressure at the point of measurement.

LCD Display with Touch Panel

The 473 has a full color LCD touch panel with a high contrast ratio and a wide viewing angle for easy readability. Data is displayed in large, easy-to-read fonts. Using the on-screen buttons and menus, you can easily configure each line of the display for a variety of humidity, temperature, and pressure parameters that may be viewed in either SI or non-SI units.

Calibration Check Function

Users can check the 473 calibration at any time using the built-in Ice Test function, which provides instant verification of system accuracy and integrity.

Connect and Go

The system is ready for immediate use.

3 Quick Start

This section guides you through the set-up and the first steps using your 473. It is a summary and should be used as a general overview and reference only. Do not use it as a substitute for the remainder of the manual. To understand your instrument thoroughly, please read the other sections carefully.

3.1 Unpacking

The 473-RP2, SH2 and SHX are delivered in a custom-fit foam-lined Peli 1550 transport case. The 473-SH3 is supplied in a cardboard carton and does not include the external PRT as standard.

The following items are included in the case:

- 473 Display Unit
- RP2, SH2, SH3 or SHX measuring head (as ordered)
- Temperature probe. Platinum Resistance Thermometer¹ (PRT)
 - The RP2 is supplied with a Ø3 x 30 mm PRT and a 0.5 m cable for extended connection between the probe and the measuring head and a 3 m cable to connect the probe directly to the back panel of the instrument.
 - The SH2 is supplied with a Ø2 x 100 mm PRT and a 0.5 m cable to connect the probe to the measuring head and a 3 m cable to connect the probe directly to the back panel of the instrument.
 - The SHX is supplied with a Ø3 x 30 mm PRT and a 1 m cable for extended connection between the probe and the measuring head.
 - The SH3 does not include a PRT as standard.
- AC power cord
- External power supply (Input: 100-240 V AC, Output: 24 V DC)
- 2 m measuring head cable
- Operation and maintenance manual
- Calibration certificate



Before starting, carefully remove these items from the case and visually check for any signs of damage. If you are missing any item or find them damaged, please call the manufacturer or your local supplier. Make sure that the power rating on the back label corresponds to your power supply specification.

¹ In accordance with IEC 60571:2008 Industrial platinum resistance thermometers and platinum temperature sensors



The instrument is calibrated with the supplied measuring head. Please be aware that the specific coefficients entered in the instruments correspond to the measuring head supplied with the instrument. Should a different measuring head be connected to the instrument, the coefficients must be changed accordingly.

3.2 Installing the Measuring Heads

The heart of the 473 Dew Point Mirror Instrument is a highly sensitive and accurate measuring head. Depending on your order, the 473 is supplied with either of the following measuring heads:



SH2



SH3

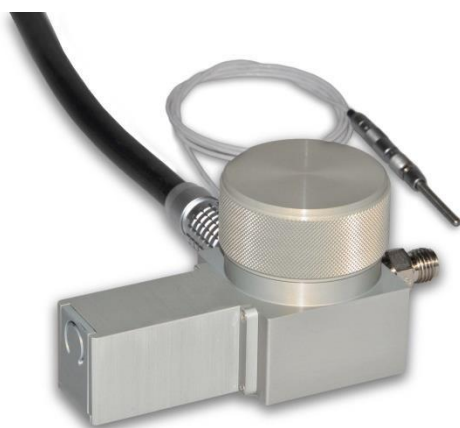

SHX



RP2

Use the supplied measuring head cable (2 m) to connect the measuring head to the back panel of the 473.

For further information on the measuring heads, please refer to sections 4.4 'Measuring Heads' and 8.2 'Mirror Cleaning'.

3.3 Starting your 473

The 473 needs a source of AC power. It will work over a wide power range and will most likely operate at your local voltage and frequency. Look at the back panel label for the power requirements of your specific instrument.

1. Connect the AC power cord to the external power supply input and the external power supply output to the back of the instrument.
2. Connect the measuring head and PRT
3. Turn the power switch to ON.

The display should become visible within a few seconds. If nothing happens, check the power source.

3.4 Dew Point Measurement

After connecting the measuring head or temperature probe, switch on the 473 and you will get an external temperature reading. If your instrument is equipped with a pressure sensor, the pressure reading will be displayed. To measure humidity (dew point, frost point, %RH, etc.), the **Dew/Frost Control** mode must be enabled and gas must be flowing across the mirror. If %RH readings are required, an external temperature probe must be connected. To connect the external temperature probe, see section 'External Temperature Probe' on page 16. Alternatively, a fixed external temperature value may be entered via the touch screen. Please follow the instructions in section 6.2 'External Temperature'.



You can test the 473 dew point measurement by measuring the dew point temperature of the room.

First, make sure the measuring head is connected to the back panel of the 473.

Next, start the measurement by pressing the **Dew/Frost Control** key. This button enables the system to cool the mirror to the dew or frost point temperature, monitor the thickness of the condensation layer on the mirror, and precisely adjust the mirror temperature to maintain a stable condensation layer. When Dew/Frost Control is enabled, the indicator on the key will turn green and the dew or frost point temperature display will begin to show the mirror temperature as it cools to the condensation point.

See section 5.2 'Selection of indicated Parameters' for information on selecting the parameters you wish to have displayed.

Fan

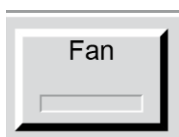

The SH2 and the SHX measuring head are equipped with a fan to pull a gas sample through the measuring head. If you are using the SH2 or the SHX measuring head, press the **Fan** key on the touch screen to turn the fan on/off. For further information on the fan refer to section 4.4 'Measuring Heads'.



SH2



SHX

4 Get to know your 473

4.1 Front Panel

The front panel of the 473 is equipped with a full color touch screen and a keypad for data entry. To activate a menu option or toggle a function on or off, simply touch the desired key or object directly on the screen.

When the 473 is turned on, the display will activate within a few seconds. A sample display configuration is shown below. The display configuration can be customized, so your display may look different. The use and the functions of the display are described in the next chapter.

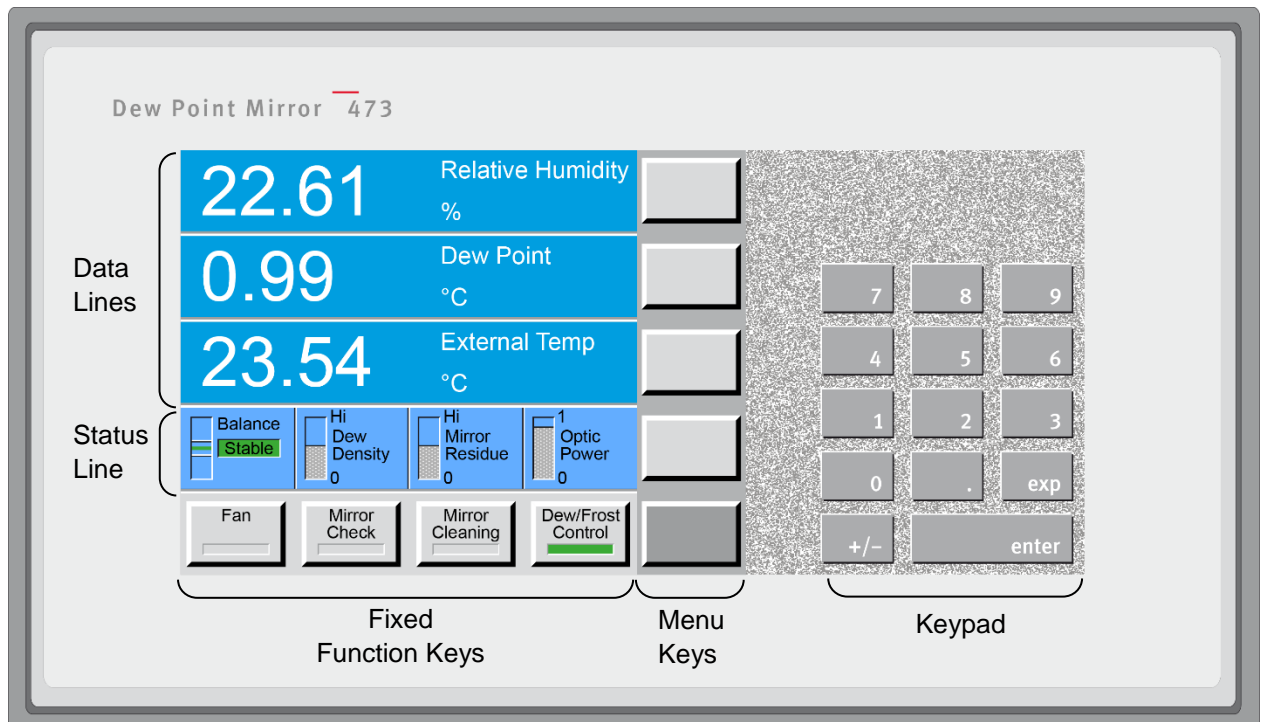

Data Lines

The first three lines of the display show a numeric or graphic representation of the measured data. We will refer to these first three lines as Data Lines.



If numeric, a data line contains the value to the left, with the parameter description and units to the right.

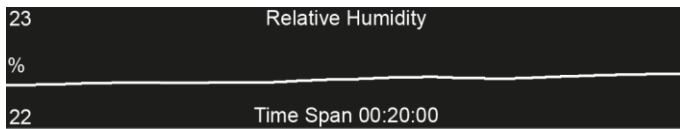

If graphic, a data line shows a simple graph of data over time.

Data can be displayed in different parameters and units either numerically or graphically. Please refer to section 5, 'System Configuration' to learn how to configure your preferences.

Status Line



Near the bottom of the display is the Status Line. The Status Line displays **Balance**, **Density**, **Contamination**, and **Optic Power**.

Balance

Although it is directly obtained from the intensity of the mirror's reflected light signal, balance is effectively the first derivative of the dew thickness measurement. It indicates the rate of growth or reduction of the condensation layer on the mirror. While the dew or frost layer on the mirror surface is growing, the indicator will be above center. The faster the layer is growing, the higher the indication. Conversely, when the layer on the mirror surface is evaporating, the indicator will be below center. The faster it disappears, the lower the indication. When the indicator is in the center, the thickness of the dew or frost layer is neither growing nor evaporating, and the layer on the mirror surface is in equilibrium with the sample gas. In this center position of the indicator, there is no net exchange of water vapor between the sample gas and the mirror surface. If the humidity of the gas sample is homogeneous and of low enough variability for the control system to sense a steady value, the Balance indicator will show a green **Stable** message, accompanied by a few short beeps.

Density

The Density Indicator graphically depicts the approximate thickness of the dew or frost layer on the mirror surface. The 473 can automatically differentiate between dew and frost layers and the indicator will display the current condensation state. The label in the density indicator will change from **Layer Density** (when the state of the layer is uncertain) to either **Dew Density** or **Frost Density** (when either dew or frost is being measured). For more information regarding Dew/Frost point determination see section 'Dew / Frost Control' on page 30.

Mirror Residue

The Mirror Residue Indicator graphically shows the amount of mirror contamination that was detected during the last mirror check. If the bar covers more than a quarter of the space, we recommend that you clean the mirror.

Optic Power

The optic power indicates the aging of the LED. When the instrument is used at higher measuring head temperatures, the LED will age more quickly. When new, the optic condition bar graph will show as 'full'. When the indication starts to decrease, it provides the user with advanced notification that the LED of the optical module may need service or replacement.

Fixed Function Keys

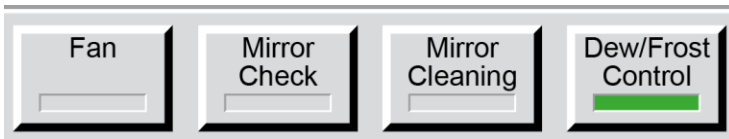

The bottom line of the display contains a row of fixed function keys. These keys are used to start and stop the gas flow fan (only for SH2 and SHX), initiate a mirror check, initiate mirror cleaning, and switch dew/frost control on or off. For further information on the fan see section 4.4, for the other functions see section 5.4.

Menu Keys and Navigation

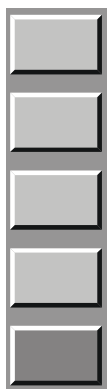

Use the dark grey key on the bottom (**menu selection key**) to move between menus.

On the right hand side of the display there is a column of menu keys. The bottom, dark gray key changes the current menu by cycling to the next menu. Each of the light gray keys changes their label and function based on the menu that is currently selected.

The menu selection is circular. Once you go past the last menu, the first one will appear again and the process starts over. You can use the \pm key on the keypad to move backward through the menus. Use the **Enter** key to exit the menu.

4.2 Touch Screen

The 473 dew point mirror is operated using the touch screen. To make a menu selection or switch functions on or off, touch the screen where appropriate with your finger or a stylus. Never use sharp objects, as damage may occur.

Before using the 473 for the first time or when several users operate this unit, the touch screen can be calibrated to suit the user. The procedure is described in chapter 8.1 'Calibrate the Touch Screen' on page 55.

4.3 Back Panel

Without Options

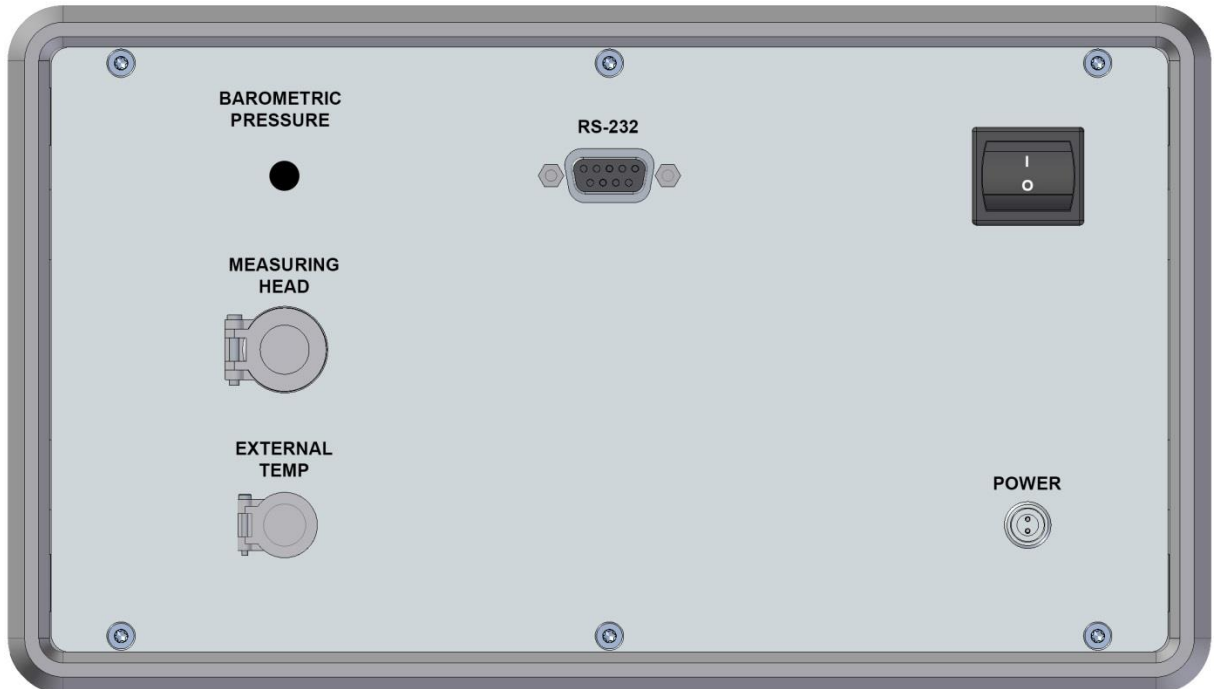

With Barometric Pressure and Analog Output Options

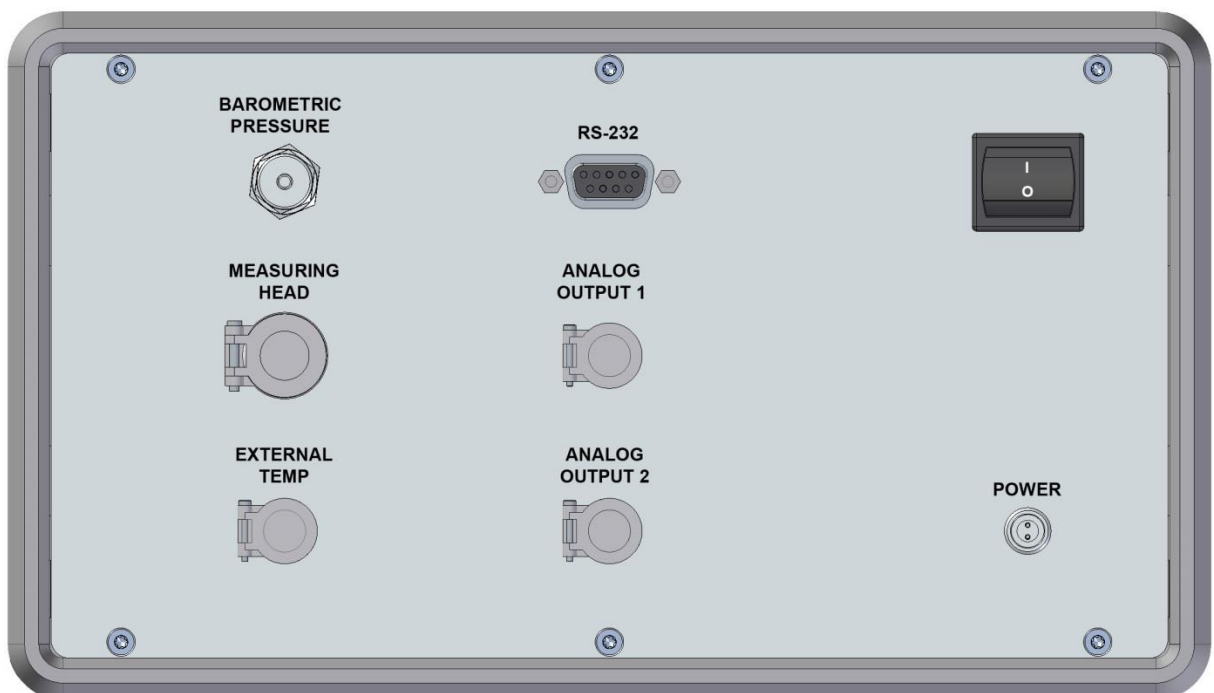

Power Switch

The main power switch is on the back panel above the power connection. The external power supply has a built-in fuse and will automatically switch off in case of overload. To restart power, the main power switch must be switched off and on again.

Power Supply

The output of the supplied external 24 VDC power supply is connected to the power connection on the instrument back panel. The supported input voltage for the power supply is 100-120 VAC / 200-240 VAC at 50 to 60Hz.

RS-232

The RS-232 port can be used to connect the 473 to a desktop or laptop computer. The necessary 9-pin RS-232 (serial) extender cable is a common accessory and can easily be obtained at any computer store.

Measuring Head Connection

The 473 can be ordered with different types of measuring heads; the RP2, SH2, SH3 and SHX. These measuring heads are connected to the back panel of the corresponding 473 display unit. The 473-RP2, SH2 and SH3 are supplied with a 19-pin measuring head cable, while the 473-SHX is supplied with a 30-pin measuring head cable.

Internal Barometric Pressure Sensor

As an option you can order an internal barometric pressure sensor to measure ambient pressure. To measure chamber pressure or to calibrate the sensor, connect a 3 mm tube with a Swagelok fitting to the pressure sensor port on the back panel.

Optional Analog Outputs

The 473 can be ordered with two optional analog outputs which are independently configurable. For each of the analog outputs, you can choose which parameter to transmit and scale its range. Please refer to section 5.7 'Configuration of Optional Analog Outputs' on page 37 to learn how to configure the analog outputs.

If the instrument is ordered with the optional analog outputs, two 4-pin LEMO connectors (Part Number: FGG.1B.304.CLAD52 www.lemo.com) will be supplied with the instrument. These can be used to make up a custom cable for your installation.

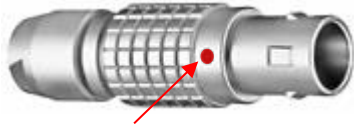

The red dot is between pin 1 and 4

When the 4-pin LEMO connector is properly assembled, the red dot of the connector housing should be between pin 1 and 4.

Pin	Signal	Position	Description
1	+V	1	
2	-V	2	
3	+I	3	
4	-I	4	

The 473 allows both a voltage and a current output signal. As shown in the illustration above, pins 1 and 2 supply the voltage signal (V), and pins 3 and 4 supply the current signal (I). Inside the instrument, the output signal is connected to a D/A converter and then split into a voltage and a current signal. Therefore, you may use either a volt or current meter to receive the analog signal. The maximum voltage output range is -10...+10 V. See the following table to identify the corresponding current signal.

Voltage [V]	Current [mA]
+10	20
2	4
0	0
-10	N/A

External Temperature Probe

The external temperature probe is used to measure the temperature of the environment that is being measured. To obtain certain humidity parameters, such as %rh, an external temperature measurement is necessary. External temperature measurements are not required for dew or frost point measurements.

- The **SH2** is supplied with a Ø2 x 100 mm PRT temperature probe. The probe can be connected to the 473 in the following ways:
 1. Use the supplied 4-pin 0.5 m cable to connect the probe to the measuring head.
 2. Use the supplied 5-pin 3 m cable to connect the probe to the back panel of the instrument.
- The **RP2** is supplied with a Ø3 x 30 mm PRT temperature probe. The probe can be connected to the 473 in the following ways:
 1. Plug the temperature probe directly into the connector on the top of the RP2 measuring head.
 2. Use the supplied 4-pin 0.5 m cable to connect the probe to the measuring head.
 3. Use the supplied 5-pin 3 m cable to connect the probe directly to the back panel of the instrument.
- The **SHX** is supplied with a Ø3 x 30 mm PRT temperature probe. The probe can be connected to the 473 in the following way:
 1. Use the supplied 4-pin 1 m cable to connect the probe to the measuring head.
- The **SH3** is not supplied with a temperature probe as standard, but where one has been specified it is connected directly to the back panel of the 473 **External Temp** connector.

Use your own External Temperature Sensor

The External Temperature plug on the back panel is used for the connection of an external temperature probe. External temperature measurements are required if certain humidity parameters, such as %RH, are to be computed. External temperature measurements are not required for dew or frost point measurements.

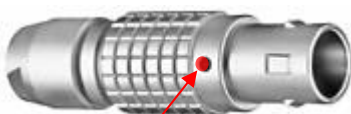

Red Dot aligns with Pin 1

If you wish to make your own thermometer cable, the 473 requires a 5 pin LEMO connector (www.lemo.ch), part number FGG 1B 305 CLAD 52.

After identifying pin 1, follow the line counter-clockwise from pin 1 to all other pins in succession. Wire the cable according to the following scheme:

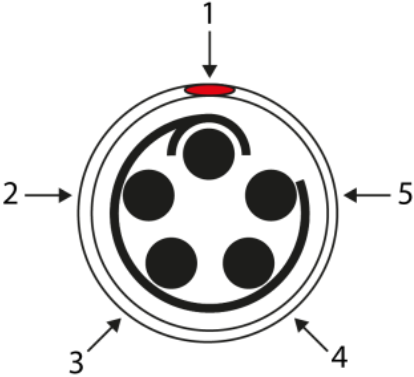
Pin	Signal	Position	Description
1	Shield		<p>When viewing the solder tabs of a disassembled 5-pin LEMO connector, pin 1 is usually identified with a full or partial circle drawn around it. Pin 5 should have no identifier. When wiring the cable, note that the pin numbering of the socket in the back panel of the instrument starts at the top left (pin 1) and goes counter-clockwise (as viewed from the rear of the unit).</p>
2	+I		
3	+V		
4	-V		
5	-I		



When the 5-pin LEMO connector is properly assembled, the red dot of the connector housing is located directly above pin 1.

4.4 Measuring Heads

The SH2 Measuring Head

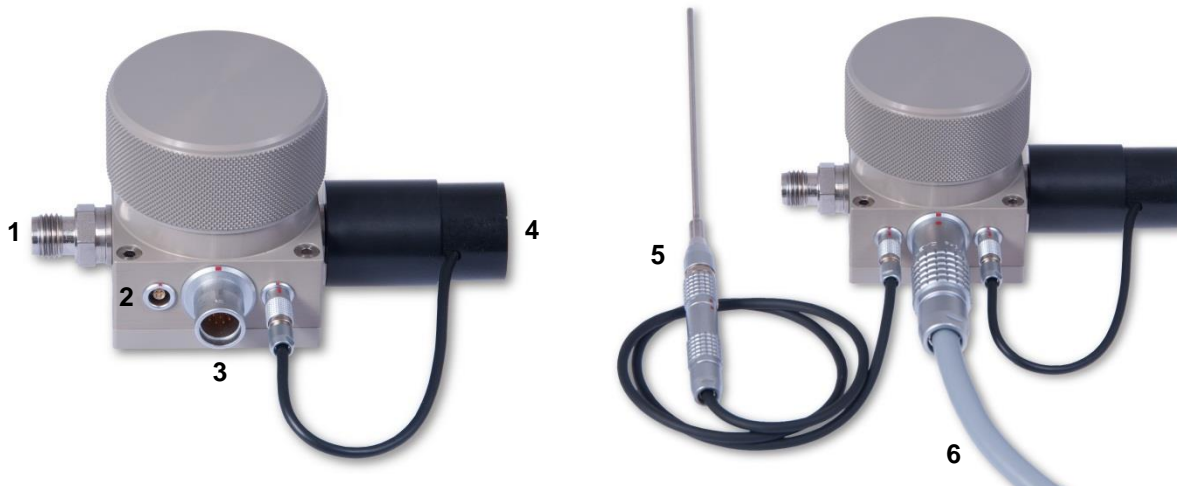

- 1. Gas Inlet
- 2. External Temperature Connection
- 3. 19-pin Measuring Head Cable Connection
- 4. Flow Fan
- 5. External Temperature Probe ($\varnothing 2 \times 100$ mm) with 0.5 m Cable (4-pin)
- 6. 19-pin Measuring Head Cable (2 m)

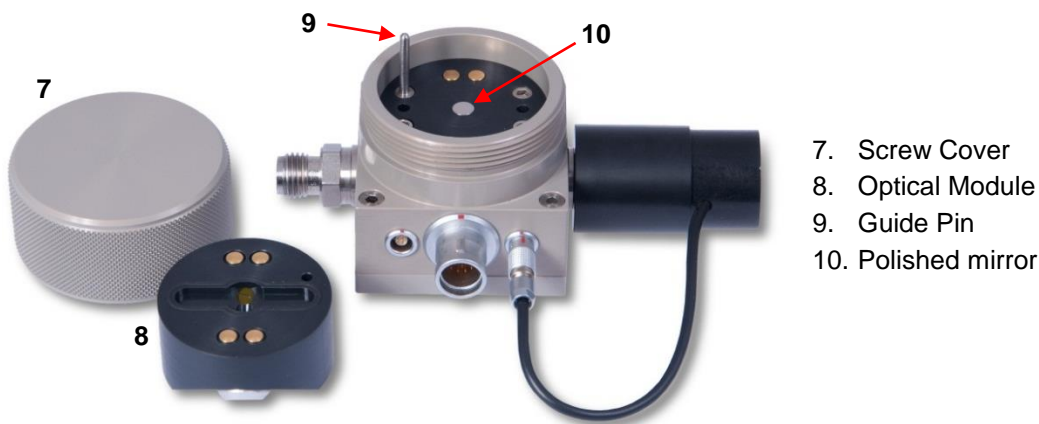

SH2 Fan

The fan of the SH2 measuring head is used to generate the necessary gas flow to the measuring head, when no other gas flow is available. The fan can be removed and replaced with an output connector (Swagelok SS-6M0-1-2RS) for direct connection of gas tubing to other instruments.

The SHX Measuring Head

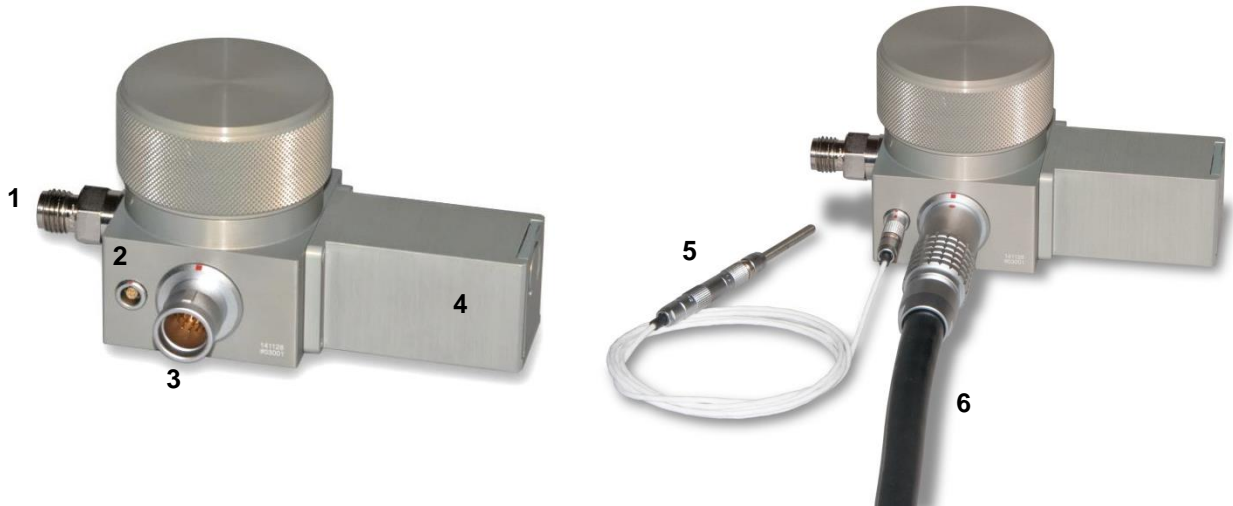

1. Gas Inlet
2. External Temperature Connection
3. 30-pin Measuring Head Cable Connection
4. Flow Fan Assembly
5. External Temperature Probe ($\text{\O}3 \times 30 \text{ mm}$) with 1 m Cable (4-pin)
6. 30-pin Measuring Head Cable (2 m)

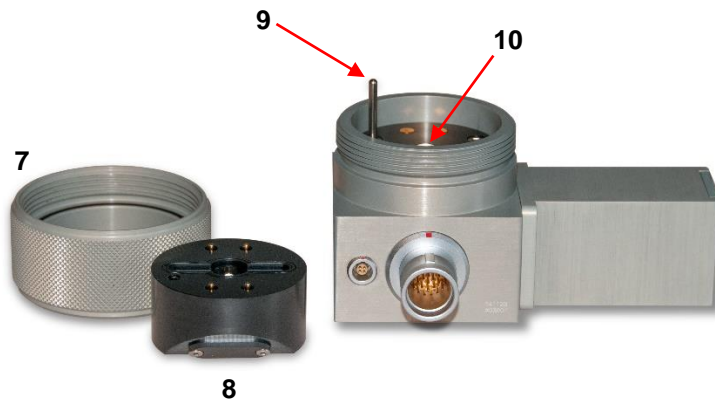

7. Screw Cover
8. Optical Module
9. Guide Pin
10. Polished Mirror

SHX Fan

The fan of the SHX measuring head is used to generate the necessary gas flow to the measuring head, when no other stable gas flow is available. The fan can be removed and replaced with an output connector (Swagelok SS-6M0-1-2RS) for direct connection of gas tubing to other instruments.

The SH3 Measuring Head

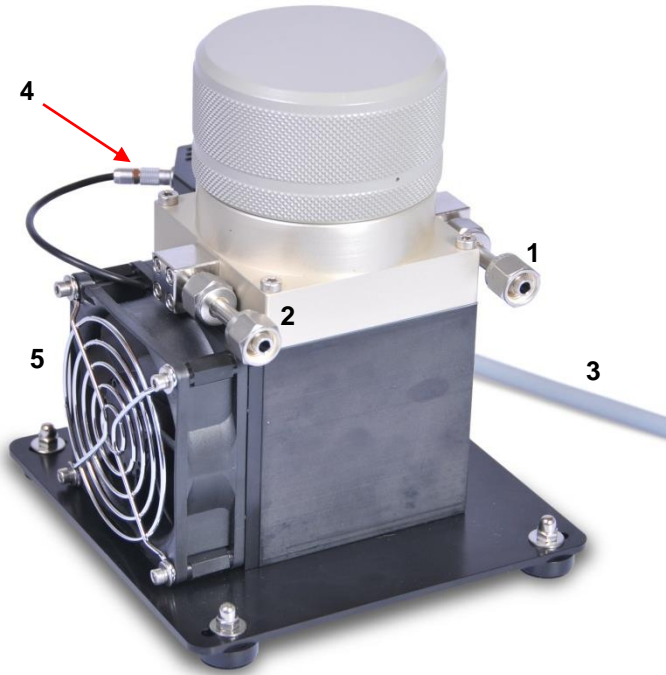

- 1. Gas Inlet (6 mm Swagelok)
- 2. Gas Outlet (6 mm Swagelok)
- 3. 15-pin Measuring Head Cable (2 m)
- 4. 2-pin Fan Cable
- 5. Measuring Head Fan

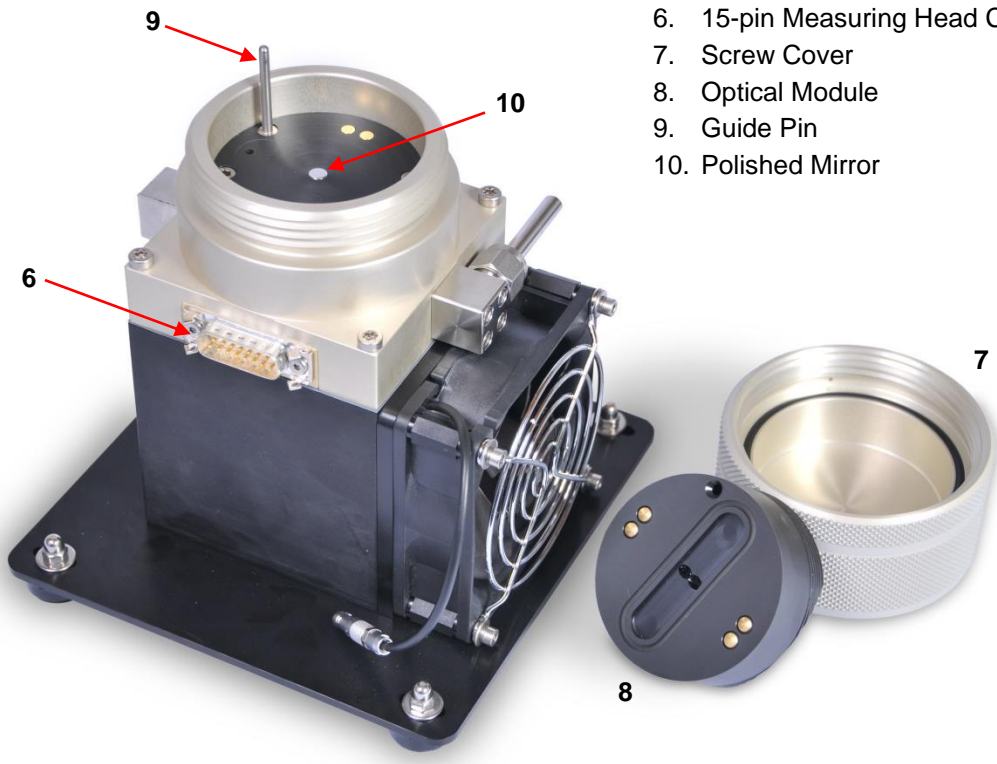

- 6. 15-pin Measuring Head Cable Connector
- 7. Screw Cover
- 8. Optical Module
- 9. Guide Pin
- 10. Polished Mirror

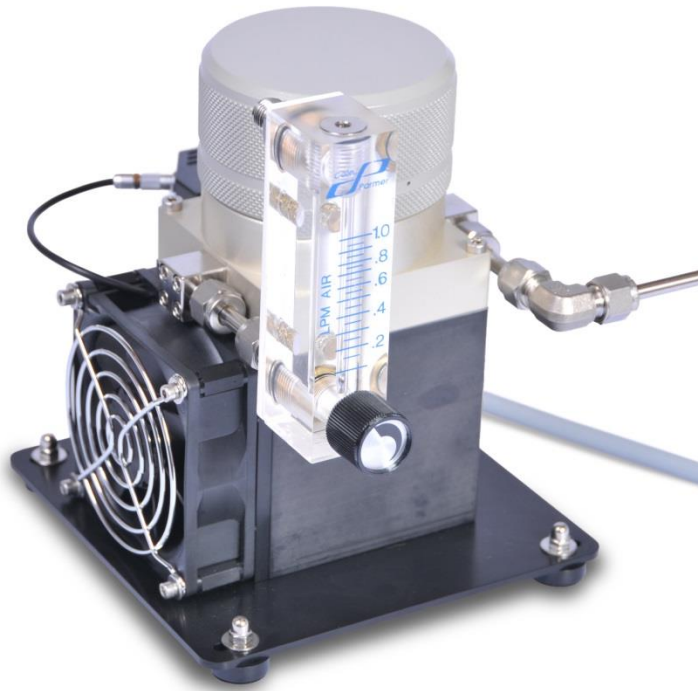

This picture shows a possible set up for the SH3 measuring head. A stainless steel tube is connected to the gas inlet. At the gas outlet there is a mechanical flow meter installed to regulate and measure the gas flow rate. We recommend 0.5 - 1 lpm for frost point measurements. A flow rate of 0.5 lpm is suitable for dew point measurements.

Please note that connecting tubes as well as flow meter are not included with the instrument.

SH3 Fan

One of the differences of the SH3 measuring head to the SH2 measuring head is that it does not have a sample gas flow fan. The purpose of the fan installed on the SH3 is to cool the measuring head base. The fan dissipates the heat generated by the Peltier during operation. This is especially important when measuring low frost points. To prevent the measuring head from overheating the fan runs continuously during operation and cannot be switched off. The **Fan** button on the display refers to the gas flow fan of the SH2. Therefore, when you have a SH3 measuring head installed and you press the **Fan** button, a message will appear saying you that there is no fan installed.

The RP2 Measuring Head



1. Temperature Probe $\text{\O}3 \times 30 \text{ mm}$
2. Measuring Head Assembly
3. 19-pin Measuring Head Cable (2 m)
4. When reassembling the measuring head take care to align the red marks.



5. External Temperature Connection

6. Polished Mirror



The 473 instrument series has three different display units depending on the type of remote cable mounted measuring head:

- 473-SH2 /-RP2
- 473-SH3
- 473-SHX

Use only the corresponding measuring head for each display unit, otherwise it will cause damage to the instrument. The SHX version is equipped with a 30-pin measuring head connection instead of the 19-pin connection used on the other versions. This makes it impossible to accidentally fit the SHX measuring head to the other display units and vice versa. However, the SH3, SH2 and RP2 use the same 19-pin connection. Therefore, caution must be taken not to connect the SH3 measuring head to the 473-SH2 /-RP2 display unit or the SH2 or RP2 measuring heads to the 473-SH3 display unit.

4.5 Carrying Handle



To adjust the position of the carrying handle, press the buttons on both sides. Release the buttons when the handle is in the desired position. Ensure that the handle has locked into place before lifting the instrument.

5 System Configuration

Many aspects of the 473 can be configured depending on your measuring needs and preferences. You can choose which humidity, temperature, and pressure values will be indicated on the screen, their order and units, and whether each will be shown as a number or as a graph. In addition to the display options, you can define how the 473 performs its control functions, such as Dew/Frost determination. Any changes in the configuration settings will remain active until the next time they are changed. Color settings will be restored to the standard settings after restarting the instrument.

5.1 The Menu

The 473 has several menus to configure the system to meet your requirements. Use the dark gray menu selection key to cycle through each of the menus. Each time you press the menu selection key, the respective label will indicate which menu is currently active. Use the \pm key on the keypad to move backward through the menus.

Use the **Enter** key on the numerical keypad to exit the menus as required. Staying in a specific menu will not affect the measurement.

List of available menus:

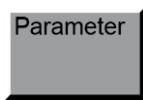

Parameter

This menu is used to select the parameters displayed on the data lines.

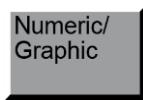

Numeric/Graphic

This menu is used to toggle a data line between numerical and graphic display.



Control Setup

This menu is used to configure the control functions like Dew/Frost Control or the Mirror Check.

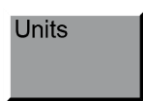

Units

This menu is used to select the units in which you would like the data to be displayed. Unit changes will be applied to all values displayed on the screen, such as temperatures, pressures and concentrations.

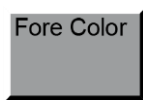

Foreground Color

The menu **Fore Color** is used to temporarily change the color of the lines drawn on graphs and the color of text (numbers and letters). The foreground color of each data line can be changed individually. Unlike other settings, the color settings will be restored to the standard color settings when the 473 is restarted.

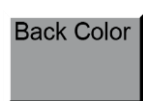

Background Color

The menu **Back Color** is used to temporarily change the color of the background of the numeric or graphic data lines. The background color of each data line can be changed individually. Unlike the other settings, the color settings will be restored to the standard color settings when the 473 is restarted.

Analog Outputs**Analog Outputs**

If the analog output option is fitted to the 473, it can be configured in this menu.

Diagnostic Functions**Diagnostic Functions**

Here you have access to the System Info, Ice Test, Peltier Cooling Test (PCT) and baud rate settings for the RS232 port.

5.2 Selection of indicated Parameters

In the *Parameter* menu you can choose which parameters you would like to have displayed on the data lines. When you select parameters for display on any of the four data lines, those selections remain valid until you change them again, even after you turn the 473 off. Below you will find the list of the available parameters.

Parameter	Explanation
Dew Point	The temperature to which a gas must be cooled to start condensing water vapor to liquid water. Dew point is pressure dependent and must be stated together with its associated pressure.
Frost Point	The temperature to which a gas must be cooled to start deposition of water vapor in the form of ice. Frost point is pressure dependent and must be stated together with its associated pressure. Frost point exists only below 0 °C. While not technically correct, it has been common industry practice to report values below 0 °C as dew point, although frost point is the correct term. For further explanation on dew or frost point refer to 'Dew / Frost Control' in section 5.4.
%RH	The ratio between the amount of water vapor in a sample and the maximum amount possible at that same temperature and pressure.
%RH WMO	The ratio between the amount of water vapor in a sample and the maximum amount possible at that same temperature and pressure calculated using the World Meteorological Organization (WMO) formula.
Volume Ratio	The ratio between the water vapor volume and the total volume of the sample gas, generally expressed in parts per million by volume, ppm _v or its numerical equivalent µl/l. Once determined, ppm _v has no further pressure dependence. It is also independent of the gas type or mixture.
Weight Ratio	Weight ratio is the ratio between the mass of water vapor and the total mass of the sample gas, generally expressed in parts per million by weight, ppm _w or its numerical equivalent mg/kg. Once determined, ppm _w has no further pressure dependence, but depends on the gas type and mixture through the molecular weight of the constituents.
Absolute Humidity	The weight of water vapor per unit volume of humidified gas.
Specific Humidity	A ratio of the water vapor to the total weight of the humidified gas.
Vapor Pressure	The partial pressure exerted by vapor in thermodynamic equilibrium with its condensed phases (solid or liquid) at a given temperature. It is usually expressed in kPa.
Head Pressure	The pressure of the gas sample in the measuring head.
External Temp	The temperature measured by the external temperature probe.
Head Temp	The temperature measured by the PRT in the measuring head.

Follow the steps below to choose the parameters you wish to have displayed on the four data lines:

1. Select the **Parameter** menu by pressing the dark gray menu selection key until **Parameter** appears. Small left pointing arrows will appear on the four upper menu keys.

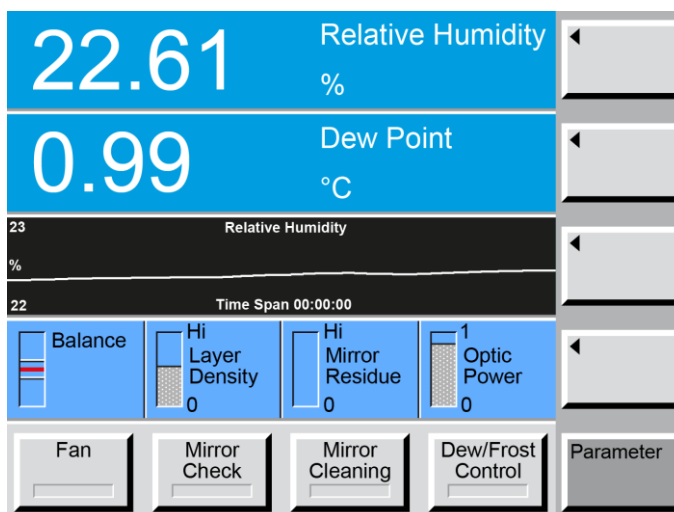

2. Press the arrow key next to the data line you wish to change. Each time you press the arrow key, the parameter of the respective line will change. Continue pressing the arrow key until the parameter you wish to view is displayed.

3. Change the parameters on any of the other data lines the same way.

4. If you choose the parameter **External Temp**, but have not connected the external temperature sensor, no reading will be displayed. If you choose parameters that require the measuring head to be connected, such as **Frost Point**, **Dew Point**, **Head Temp**, **% RH**, **Humidity**, **Volume Ratio**, **Weight Ratio**, **Vapor Pressure**, or **Head Pressure** please make sure all the relevant equipment is connected for the instrument to be able to display the chosen parameters.

5.3 Selection of Numeric or Graphic Data Display

Any data line may be viewed either in a numeric or a graphic format. The 473 automatically keeps a short data history of every selectable parameter so that a graph appears instantly whenever a data line is switched from numerical to a graphic mode. Use the **Numeric/Graphic** key to toggle any data line between numerical or graphic mode.

1. Use the dark gray menu selection key to select the **Numeric/Graphic** menu. Small left-pointing arrows will appear on the four upper menu keys.
2. Press the arrow key next to the data line that you wish to change. The data line will toggle between numerical and graphic mode each time you press the key.

Graph Scaling

Each graph can have its own x and y-axis scaling and range settings. There are three different scaling modes to choose from; **Autoscale Minimum** (which is the default setting), **Fixed Range** or **Minimum/Maximum**. Each of these is explained in more detail below. You can change the graph scaling and switch between the three scaling modes at any time.

1. On the screen, touch the graph you wish to change. A graph scaling dialog box will appear. One of the buttons in the **Description** column will have a green indicator. This shows you the currently selected mode.
2. If you would like to change the scaling mode, touch the button of the mode you would like to select. Note that for the **Minimum/Maximum** option, only the **Maximum** button needs to be selected (the **Minimum** is then automatically selected by the system).

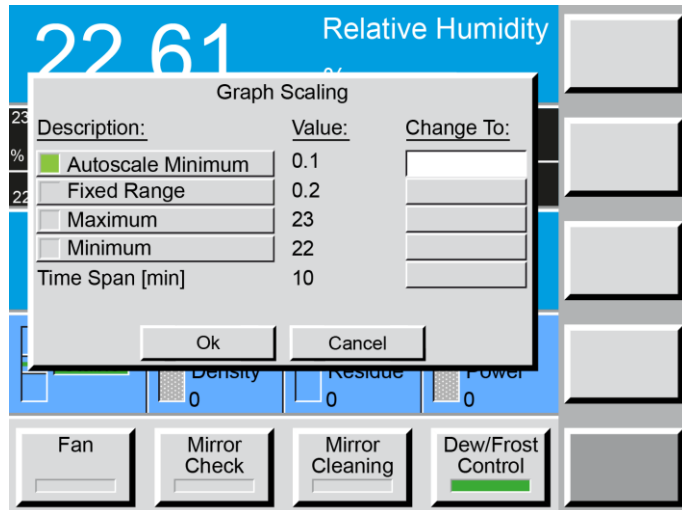

3. Touch the corresponding field in the **Change To** column, next to the range that you have selected.
4. Using the numerical keypad, enter the value needed. If you make a mistake while entering the value, touch the field you are editing on the screen. With each touch, the last digit in the field will be erased.
5. Once you have entered the correct value, press the **Ok** button (or the enter key on the numeric keypad) to confirm. Press the **Cancel** button if you wish to abort all changes made in the dialog box.



Any values you enter will only be accepted by the system if they correspond with the selected mode. If, for example, you enter a value into the bracket next to the **Autoscale Minimum**, but **Fixed Range** is the selected mode, the **Autoscale Minimum** value will remain unchanged.

Autoscale Minimum

The Autoscale Minimum mode is the default setting for this instrument. This mode sets the scaling automatically so that all of the stored data will be visible on the graph at the best possible resolution. As the range of the data changes, so will the range of the graph. In Autoscale Minimum mode, you can select the minimum range that you want the graph to scale to. For viewing temperature and dew or frost point graphs, setting the Autoscale Minimum to a value of 0.1 or greater is generally a good choice. It allows the graph range to close in on the data as it stabilizes at a single value without the range of the y-axis becoming too narrow.

For example, setting an Autoscale Minimum of 0.1 while the 473 is displaying a graph of a steady dew point measurement of 20.0 °C will set the minimum and maximum value limits of the graph to 19.95 °C and 20.05 °C, respectively. The graph will also zoom out as needed if a reading goes outside that range. You can experiment with this value to determine your personal preference.

Fixed Range

The Fixed Range mode allows you to select a fixed range for the graph's y-axis. It automatically centers on the most recent data point. As the most recent data varies, so will the center point of the graph, leaving the overall range fixed. The Fixed Range mode is mostly used to monitor data for stability. For example, if you set the fixed range for the external temperature graph to 0.2 and the current data is 23.00 °C all data between 22.80 °C and 23.20 °C is visible on the graph.

Minimum/Maximum

In the Minimum/Maximum mode you can specify the minimum and maximum values used for the graph's y-axis. Unlike the other modes, the visible range of the graph's y-axis will not automatically change if a data point is outside the set minimum/maximum range. If the data points are outside the specified range, you will not see them on the graph.

Time Span

Time Span determines the number of minutes of the data history that is visible on the graph. The 473 stores a fixed number of data points independent of the selected time span. Thus, changing the time span will change the time interval at which the data points are stored. The total number of stored data points will not change. With a time span of 15 (15 minutes), the graph data is sampled and stored every few seconds. With a time span of 120 (2 hours), the graph data is only sampled, stored, and updated about once a minute.

When you change the time span, the data that was sampled and stored at the old interval will be incrementally replaced by new data sampled at the new interval. The time span indicated on the graph will always reflect the actual time span of the data that is displayed on the graph, and will agree with the time span you selected once enough data points have been sampled. The selected time span is common to all graphs, so they will always have the same time relationship to one another.

The time span can be changed in the Numeric/Graphic menu:

1. Touch the graph you wish to change on the screen. The Graph Scaling dialog box will appear.
2. Touch the **Change To:** field next to **Time Span**. The field will turn white.
3. Use the numerical keypad to enter an *even* value between 2 and 1440. As you enter the value it will appear in the white **Change To:** field of the dialog box.
4. If you make an entry error, touch the field that holds the number you wish to change. Each time you touch the field, the last digit entered will be deleted.
5. Press the OK button in the dialog box or press Enter on the key board to confirm the new value. Press Cancel to leave it unchanged.
6. The result will take some time to show as the old data at the old time interval will be replaced by data at the new time interval gradually as determined by your selected time span.



If you prefer to see the same measurement as both numerical value and graph, you may select the same parameter on two data lines, and set one line to graph mode and the other to numeric mode. See sections 5.2 and 5.3 for instructions on selecting displayed parameters and changing their display modes.

5.4 Control Setup

Using the **Control Setup** menu enables you to control the manner in which the 473 operates.

Dew / Frost Control

When measuring dew/frost points between 0 °C and -20 °C, condensation on the instrument's chilled mirror may be in the form of dew, frost, or a combination of both. If the state of the condensation is not known, it will introduce errors into all the humidity measurements reported by the instrument.

To eliminate this potential source of error, the Force Frost function is used to rapidly cool the mirror to below -20 °C, forcing all dew on the mirror into frost. The mirror will then re-stabilize at the frost point temperature. Once the condensate layer is in a state of frost, it will remain frost for all sub-zero mirror temperatures, allowing the instrument to measure the frost point accurately. The dew point and all other humidity measurements are then mathematically calculated from the frost point.

To change the **Force Frost** settings:

1. Select the **Control Setup** menu by pressing the dark gray menu selection key until **Control Setup** appears.
2. Touch the **Dew/Frost Control** button. The Mirror **Dew/Frost Control** window will open.
3. The Force Frost function can be enabled or disabled by clicking on the **Force Frost Below** button. If the indicator on the left side of the button is green, Force Frost is enabled. If the indicator is grey, Force Frost is disabled.
4. To adjust the temperature below which Force Frost activates, click on the **Change To:** field to the right of the Force Frost Below button. The field will turn white.
5. Enter the temperature in degrees C below which Force Frost should activate.
6. If you make an entry error, touch the field that holds the number you wish to change. Each time you touch the field, the last digit entered will be deleted.

Press the **OK** button in the dialog box or press Enter on the keypad to confirm the new value. Press Cancel to leave it unchanged.

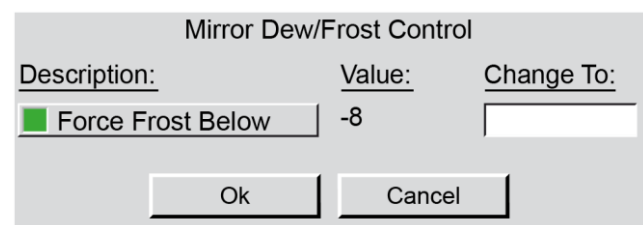



Why it is Important to Distinguish Between Dew and Frost

For mirror temperatures above 0 °C, water vapor always condenses on the mirror in its liquid phase (dew). A condensation layer on a mirror above 0°C is therefore always considered a dew point.

Although ice always starts melting at exactly 0 °C, water will not necessarily freeze at 0 °C. Water may stay in its liquid phase at temperatures far below 0 °C. This phenomenon is referred to as 'Super-Cooled Water'.

The fact that water at subzero temperatures can condense either as dew or as frost makes it somewhat difficult to determine whether the condensate layer on the mirror at temperatures below 0 °C is liquid or solid. Various factors such as contaminants, time, pressure etc. may cause the condensate layer to remain liquid at mirror temperatures of –20 °C and below.

It is furthermore important to understand that the difference in the temperature at which the liquid or the solid condensate layer stabilizes can be up to 3 °C. As shown on the picture to the right, it is also possible that dew and frost exist concurrently on the mirror which results in a non-stable value reading somewhere between the dew and frost point.

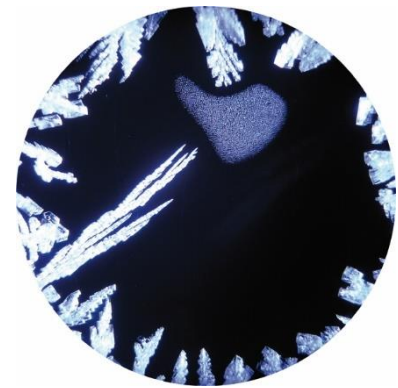

Therefore the phase of the condensate must be known in order to avoid significant errors and to correctly calculate all humidity values, including vapor pressure, dew point, %RH, volume ratio, weight ratio, absolute humidity and specific humidity.

It would be desirable for manufacturers and users of humidity instruments to use the term *frost point* for temperatures below zero and *dew point* for temperatures above zero. While not technically correct, it has been common practice to use *dew point* for temperatures below 0 °C, although *frost point* would be the correct term. As discussed above, *dew point* can exist below 0 °C in the form of super-cooled water and is different in value from the equivalent *frost point* temperature. For the same vapor pressure, the *frost point* is approximately 10% of reading above the corresponding *dew point* value (when expressed in °C). For example, a vapor pressure of 38 Pa corresponds to a *frost point* of –30 °C and a *dew point* of –33 °C. From a measuring perspective it seems obvious that a clear and consistent distinction between dew and frost point is important.

Mirror Cleaning

Activating the Mirror Cleaning function with the respective key at the bottom of the screen will heat the mirror to a pre-specified temperature, getting the measuring head ready for the removal of the cover and the optical module. If the mirror and other internal measuring head components are disassembled while they are cold and become exposed to normal atmospheric air, the possibility of undesired condensation exists. Warming the mirror and other internal components to a safe head removal temperature, greater than or equal to the current ambient temperature, will prevent the formation of dew on the mirror assembly during servicing.

To set the Minimum Mirror Temperature when activating the Mirror Cleaning mode:

1. Select the **Control Setup** menu by pressing the dark gray menu selection key until **Control Setup** appears.
2. Touch the **Mirror Cleaning** menu button.
3. Touch the **Change To:** field to the right of the **Minimum Mirror Temp** label.

Description:	Value:	Change To:
Minimum Mirror Temp	20	<input type="text"/>

Ok Cancel

4. Enter the temperature in degrees C which the mirror must warm to during the Mirror Cleaning mode. It is recommended that you enter your current ambient temperature or higher.
5. If you make an entry error, touch the field that holds the number you wish to change. Each time you touch the field, the last digit entered will be deleted.
6. Press the OK button in the dialog box or press Enter on the keypad to confirm the new value. Press Cancel to leave it unchanged.

Mirror Check

Mirror Check is the process of warming the mirror to evaporate all condensation, looking for the presence of contamination and accounting for it if necessary, then initiating a new dew or frost point measurement. Mirror Check may be started manually with the fixed **Mirror Check** key, or if enabled, it will start automatically at pre-specified time intervals.

During a mirror check, whether triggered automatically or manually, the indicator on the fixed **Mirror Check** key has the following meanings:

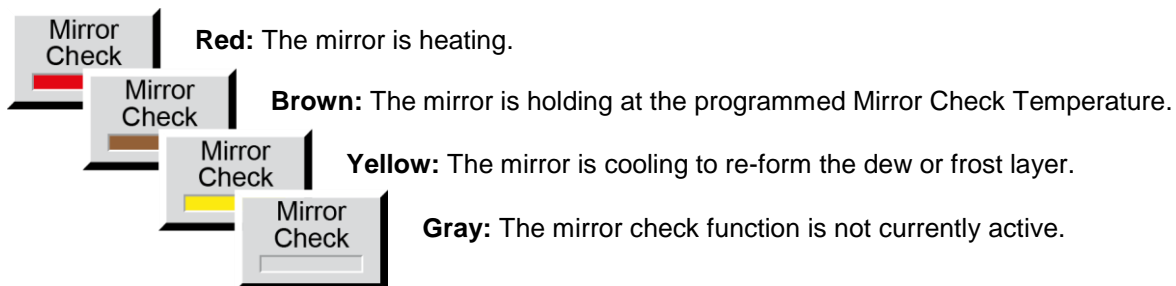

Once the system has re-established a dew or frost layer and become stable, the mirror check function is completed and the color indicator turns gray.

After the Mirror Check is completed the bar of the Mirror Residue Indicator shows the amount of contamination on the mirror. If the bar covers more than a quarter of the space, we recommend that you clean the mirror. For instructions on mirror cleaning, please refer to section 8.2 'Mirror Cleaning'.

Automatic Mirror Check

To view or edit the Mirror Check parameters, press the **Mirror Check** key of the **Control Setup** menu.

If automatic mirror checks are desired, select it by pressing the **Cycle Time** button. A green light on the button indicates that automatic mirror check is enabled.

Description:	Value:	Change To:
<input checked="" type="checkbox"/> Cycle Time [min]	60	<input type="text"/>
Heating time [min]	0	<input type="text"/>
Temperature [°C]	40	<input type="text"/>

Ok Cancel

When the automatic mirror check is enabled, the **Mirror Check** key at the bottom of the screen shows a countdown timer indicating the time before the next automatic mirror check is performed. In the automatic mode, the mirror check may still be initiated manually by pressing the **Mirror Check** button.

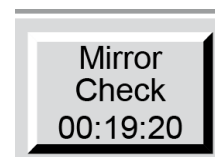

Cycle Time

The **Cycle Time** is the number of minutes between automatic mirror check operations. Use the numerical keypad to enter the desired cycle time in minutes.

Heating Time

The Heating Time determines how long the mirror check temperature will be held before allowing the next dew or frost point measurement. A heating time of 0 means that the instrument will resume dew or frost point measurement immediately upon reaching the mirror check temperature. If a heating time greater than 0 is entered, the mirror will heat and remain at that temperature for the chosen duration. Heating time is effective regardless of whether mirror check is triggered automatically or manually.

Temperature

Edit the **Temperature** field to change the temperature, in degrees Celsius, that the mirror will be heated to, and optionally held at during Mirror Check.



If you have entered a wrong value into a field and want to erase it, press the entry field to backspace.

Fan Settings

The 473-SH2 and 473-SHX versions include a fan that allows the instrument to extract a sample from the application for measurement. The fan has variable power (range 20...100%) so that the user can change the flow rate. It is recommended that the fan power is set within the range 20...40% for typical use, that is with no or little tubing in front of the measuring head.

To adjust the fan settings:

1. Select the **Control Setup** menu by pressing the dark gray menu selection key until **Control Setup** appears.
2. Touch the **Fan** menu button.
3. Touch the **Change To:** field to the right of **Fan Power [%]**.
4. Enter the percentage value at which you would like the fan to operate.
5. If you make an entry error, touch the field that holds the number you wish to change. Each time you touch the field, the last digit entered will be deleted.

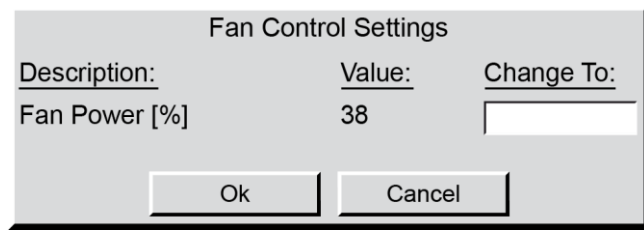

Press the *Ok* button in the dialog box or press *Enter* on the keypad to confirm the new value. Press *Cancel* to leave it unchanged.

The following figure shows the typical² performance curves for the SHX flow module (measured including the measuring head). If the flow restriction of your setup is known you can derive an adequate power setting by choosing the power setting at the intersection of desired flow and your flow restriction (in Pa).

SHX Flow Module Performance Curves for different power settings

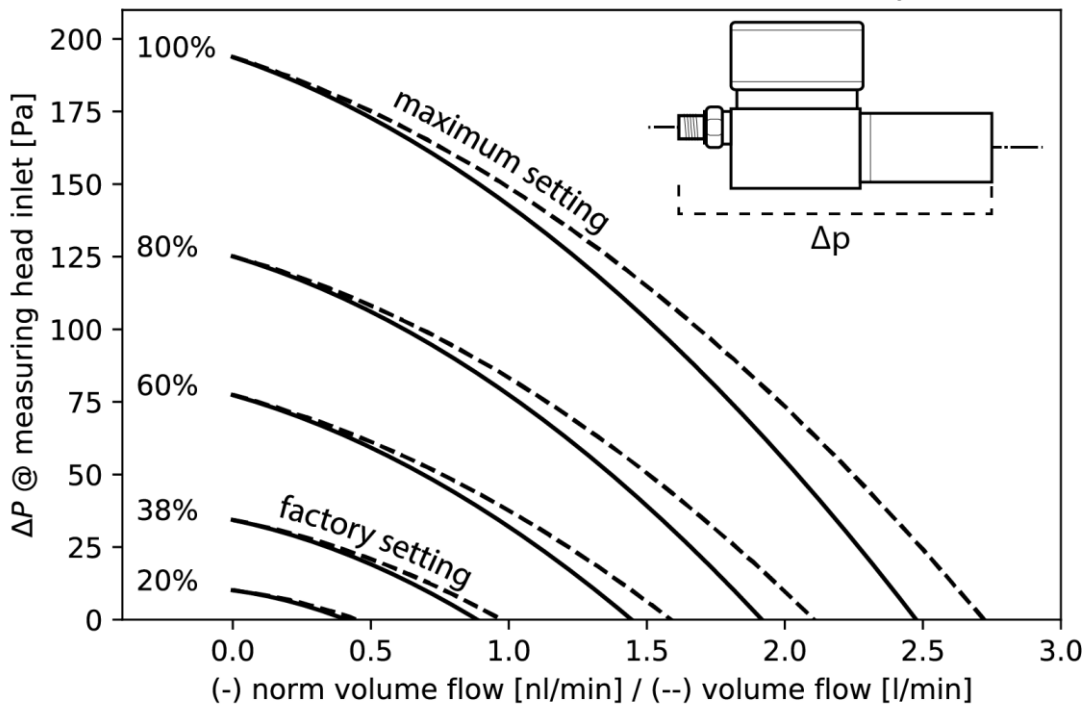

² The performance is only slightly reduced in high temperatures (~10% @ 125°C)

5.5 Selection of Units

You can display system data in any of a wide variety of units. When you change units, your selection will remain until you change it again. Unit selections are global, which means that all values of that parameter type across the whole system will change to the chosen units. For example, changing the temperature units to °C will display *all* temperature data in °C.



Data retrieved via RS-232 will *always* be in SI units regardless of the units chosen for display. Also note that settings within dialog boxes used for changing system parameters are entered and displayed in SI units. Units only affect the four data lines.

Available units are:

Temperature Units	°C, °F or K
Pressure Units	Pa, hPa, kPa, MPa, atm, bar, mb, inHg, mmHg, cmHg, inH ₂ O, mmH ₂ O, cmH ₂ O, Torr or psia
Flow Rate Units	l/min, ml/min, l/h, cfm, or cfh
Absolute Humidity Units	g/l, g/m ³ , mg/m ³ or lb/ft ³
Specific Humidity Units	g/g, g/kg or lb/lb
Vapor Pressure Units	Pa, hPa, kPa, MPa, atm, bar, mb, inHg, mmHg, cmHg, inH ₂ O, mmH ₂ O, cmH ₂ O, Torr or psia

5.6 Selection of Color

The foreground and/or background color of any data line can be changed in the **Fore Color** and **Back Color** menus. Access the **Fore Color** and **Back Color** menus with the menu selection key. To revert to the default color scheme, press and hold key number 9 on the keypad for a few seconds until the instrument beeps.

Foreground Color

The foreground color is the color of the numbers and letters. To change a data line's foreground color:

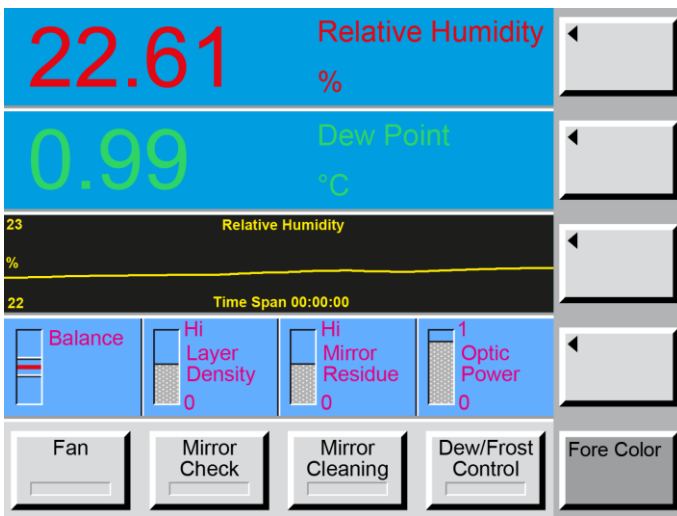

1. Access the **Fore Color** menu. **Fore Color** will appear on the dark gray menu key, and the keys above will show left-pointing arrows. Note that each of the upper keys correspond to the data lines they point to.
2. Press the arrow key of the data line you wish to change. Note that the foreground color of the data line will change with each touch of the key.
3. Change the foreground color on any of the other data lines the same way.

Background Color

To change a data line's back color:

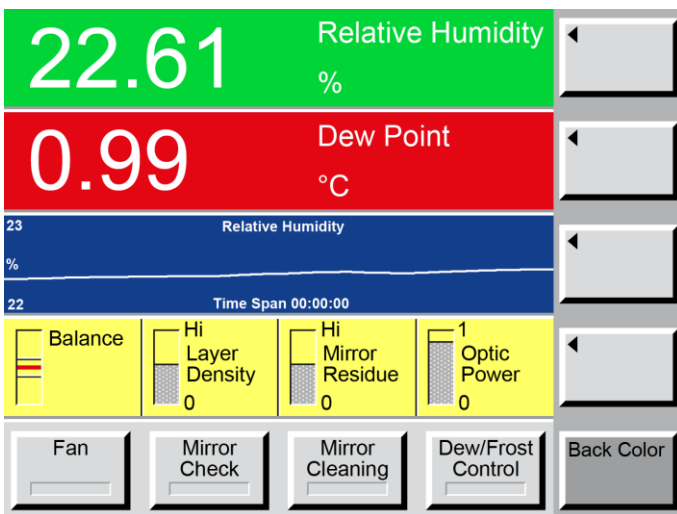

1. Access the **Back Color** menu. **Back Color** will appear on the dark gray menu key, and the keys above will show left-pointing arrows. Note that each of the upper keys correspond to the data lines they point to.
2. Press the arrow key of the data line you wish to change. Note that the background color of the data line will change with each touch of the key.
3. Change the background color on any of the other data lines in the same way.

5.7 Configuration of Optional Analog Outputs

For each of the analog outputs, you may select which parameter to track and how to scale the selected parameter to the analog output range. These selections are made for each of the analog outputs via the **Analog Outputs** menu.

1. Access the **Analog Outputs** menu with the menu selection key.
2. To make the selections for the first analog output, press the **Analog Output 1** key.
3. Use the numerical keypad to enter the desired values. For details on each option, read the three following subsections.
4. Follow the same procedure for the second or any subsequent analog outputs as needed.

Analog Output 1		
Description:	Value:	Change To:
Parameter	0	<input type="text"/>
Min Value	-100	<input type="text"/>
Max Value	100	<input type="text"/>
Min Voltage	-10	<input type="text"/>
Max Voltage	10	<input type="text"/>
D/A Cal Gain	1	<input type="text"/>
D/A Cal Zero	0	<input type="text"/>
<input type="button" value="Ok"/> <input type="button" value="Cancel"/>		

Selection of Parameter to Track

In the analog configuration window, enter the number which corresponds to the parameter you wish to track. Use the following table to identify which number to enter into the **Parameter** field. For example if you wish to track the external temperature, enter number 11 into the entry field next to **Parameter**.

Parameter	Units	Enter this #
Dew Point	[°C]	0
Frost Point	[°C]	1
RH	[%]	2
RH WMO	[%]	3
Volume Ratio	[PPMv]	4
Weight Ratio	[PPMw]	5
Absolute Humidity	[g/m ³]	6
Specific Humidity	[g/kg]	7
Vapor Pressure	[Pa]	8
Head Pressure	[Pa abs]	9
Flow Rate	[l/min]	10
External Temperature	[°C]	11
Head Temperature	[°C]	12

Scaling the Output Signal

Use **Min Value** and **Max Value** to set the range of the Parameter, and use **Min Voltage** and **Max Voltage** to set the range of the analog output signal.

Example 1

1. You want to track the parameter **%RH** as an analog voltage output. The previous table shows that the parameter **%RH** has been allocated number **2**. Enter number **2** into the field next to **Parameter**.
2. The next step is to define the range of **%RH** which will be covered with the analog output signal. You want to have the whole range of 0...100%. Enter **0** into the field next to **Min Value** and **100** into the field next to **Max Value**.
3. Then, set the scaling of the analog output signal. You want to have 0...1 VDC on the analog output to represent the 0...100 %RH. Enter **0** into the field next to the **Min Voltage** and **1** into the field next to **Max Voltage**.

Analog Output 1		
Description:	Value:	Change To:
Parameter	2	<input type="text"/>
Min Value	0	<input type="text"/>
Max Value	100	<input type="text"/>
Min Voltage	0	<input type="text"/>
Max Voltage	1	<input type="text"/>
D/A Cal Gain	1	<input type="text"/>
D/A Cal Zero	0	<input type="text"/>

Ok Cancel

Example 2

To keep things simple, we will take the same **Parameter, Min Value and Max Value** settings as in the first example. However, this time you want the analog output range to be scaled to mA instead of volts. Your selected range is 4...20 mA for the parameter range of 0...100 %RH. In order to enter this into the system, please refer to the table on page 37 to find the voltage which corresponds to your desired mA output range. You will find that 2...10 V corresponds to 4...20 mA. Thus, enter **2** into the field next to **Min Voltage** and **10** into the field next to **Max Voltage**.

Analog Output 1		
Description:	Value:	Change To:
Parameter	2	<input type="text"/>
Min Value	0	<input type="text"/>
Max Value	100	<input type="text"/>
Min Voltage	2	<input type="text"/>
Max Voltage	10	<input type="text"/>
D/A Cal Gain	1	<input type="text"/>
D/A Cal Zero	0	<input type="text"/>

Ok Cancel

Calibration Adjustment

D/A Cal Gain and **D/A Cal Zero** are used to adjust the analog output signal accuracy. This adjustment is made at the factory and will rarely need to be changed by the user.

5.8 Diagnostic Functions

System Information

When you press the **System Info** button in the **Diagnostic Functions** Menu a window appears which gives you information about the model of the instrument, the version of the software and the serial number of the instrument.

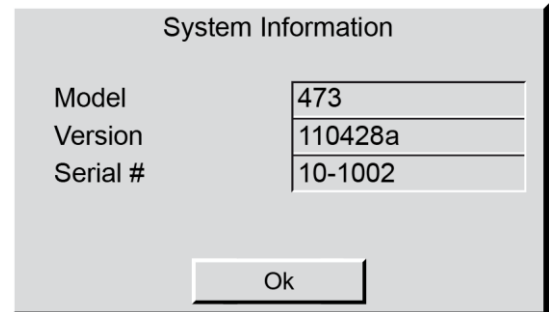

Ice Test

The measuring accuracy can be checked with a simple, built-in test. The test may be performed at any time, and is recommended whenever the results of your normal measurements do not correspond to expectations, and you suspect that there may be an error with the instrument.



The mirror must be visible to perform the Ice Test. If you have an SH2, SH3 or SHX measuring head, remove the measuring head cover prior to the Ice Test as described in section 8.2 'Mirror Cleaning'. If you have an RP2 measuring head, disassembly is not necessary as the mirror is visible from the outside.

The Ice Test cannot be started as long as a dew/frost point measurement is in progress. Make sure that the bar on the **Dew/Frost Control** key is grey.

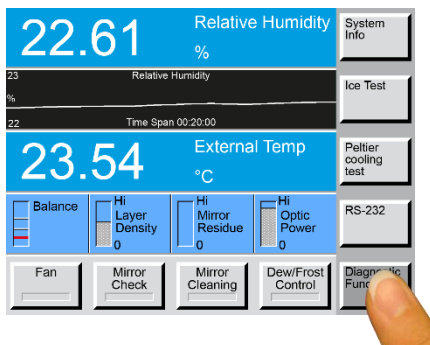

Press the menu selection key on the lower right to select the **Diagnostic Functions** menu. Then press the **Ice Test** button.



Please note that the Ice Test will start immediately after the **Ice Test** button has been pressed.

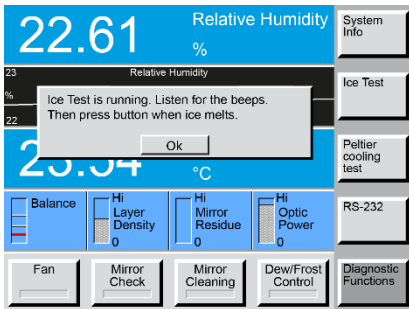

During the Ice Test, the mirror rapidly cools to approximately -30 °C. Because the measuring head is open, humidity from the ambient air starts to condense on the mirror. This forms a frost layer on the mirror which can be facilitated if necessary by blowing on it. After reaching the low temperature and forming ice on its surface, the mirror begins to heat. As the temperature approaches 0 °C, the instrument will beep increasingly rapidly as the mirror gets closer to the ice-melting temperature.

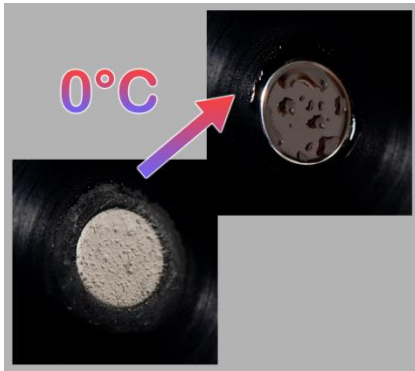

Watch the mirror closely. As soon as the mirror temperature reaches 0 °C, the ice will melt into liquid water drops (phase transition).

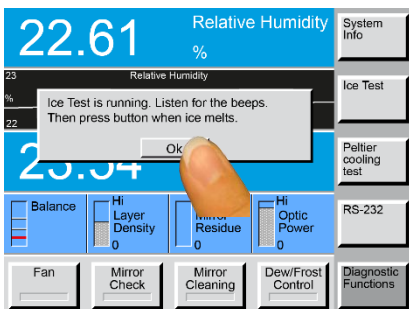

When you observe the phase transition on the mirror, press the **Ok** button. The mirror temperature is measured at that moment and a dialog box appears with the test results.

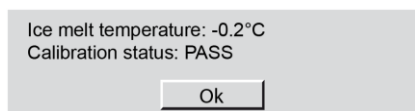

If the measured ice-melt temperature was in the range of ± 0.2 °C, the check is successful and will be indicated with the calibration status **PASS**.

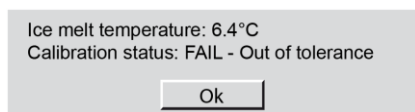

If the measured ice-melt temperature was outside the range of ± 0.2 °C, the check was not successful and will be indicated with the calibration status **FAIL**. In this case the ice test should be repeated. If it continues to fail, the instrument should be sent to the manufacturer or an authorized agent for evaluation and/or repair.

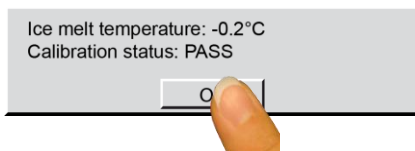

Press the **Ok** button on the **PASS/FAIL** status window.

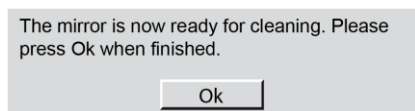

The next window requests that you clean the mirror.

Clean and reassemble the measuring head as described in section 8.2 'Mirror Cleaning'.

Peltier Cooling Test

The Peltier module used for mirror cooling and heating can age over time. It can also lose capability when used at its limits. If you think the measuring head is not cooling down fast enough during measurement, you can check this with the Peltier Cooling Test (PCT) function.

This function will perform a stress test of the Peltier module. It cools the Peltier module down for two minutes with the highest allowed current (5 Amps). During this test, the measuring head will heat up a little as power from the Peltier module is dissipated.

You will find the button **Peltier Cooling Test** on the **Diagnostic Functions** menu. Before you start, please let the device cool down or heat up to near ambient temperature. If you press the **Peltier Cooling Test** the test will start immediately.

During this test the following is displayed:

- **Time:** Countdown in seconds until the test ends. The duration of the test is two minutes.
- **TH:** Temperature of the measuring head
- **TM:** Actual temperature of the mirror
- **TMdelta:** Delta between head temperature and mirror temperature
- **PLT:** Peltier current. A negative value means that the mirror is being cooled. → Check and note that value

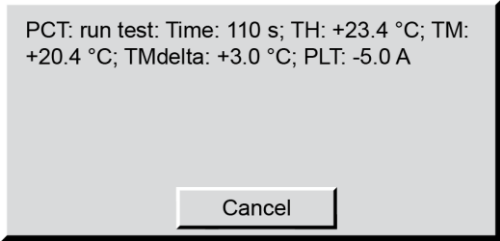

PCT: run test: Time: 110 s; TH: +23.4 °C; TM: +20.4 °C; TMdelta: +3.0 °C; PLT: -5.0 A

Cancel

After this test, the instrument displays the following results:

- **Cool index:** Calculates a speed index for the first 40 °C of cooling (kelvin per second)
- **Max Delta:** Maximum delta between head and mirror temperature during test
- **Min TM:** Lowest mirror temperature reached during test
- **TH:** Head temperature at the end of the test

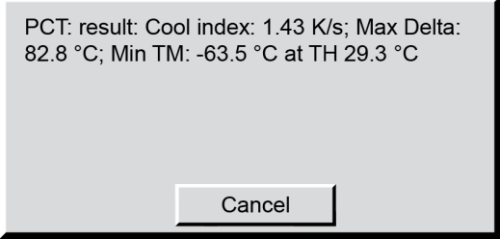

PCT: result: Cool index: 1.43 K/s; Max Delta: 82.8 °C; Min TM: -63.5 °C at TH 29.3 °C

Cancel

Following results indicate a successful test:³

- **Cool index:** Should be higher than 1 °K/s
- **Max Delta:** The reached Delta should be higher than 50 °C, at laboratory conditions of about 23 °C ambient temperature. New instruments typically have a Max Delta of > 60 °C.
- **PLT:** Peltier current during test should be around 1.5 Amps

³ These results apply for model RP2, SH2 and SHX, but not for SH3 due to several available variations. Please contact MBW for more information.

RS-232 Configuration

The RS-232 Configuration window allows you to change the baud rate on the serial port. Default setting is 9600 Baud.

To change the **RS-232 Configuration**:

1. Select the **Diagnostic Functions** menu by pressing the dark gray menu selection key until **Diagnostics Functions** appears.
2. Touch the **RS-232** button. The **RS-232 Configuration** window will open.
3. To change the baud rate value touch the gray **Change To:** field. The field will turn white.
4. Enter the desired baud rate. (1200, 2400, 4800, 9600, 19200, 38400, 57600, 115200 are possible values)
5. If you make an entry error, touch the field that holds the number you wish to change. Each time you touch the field, the last digit entered will be deleted.

<u>Description:</u>	<u>Value:</u>	<u>Change To:</u>
Baud Rate	115200	<input type="text"/>

Ok Cancel

6 Set Up and Operation

6.1 Measurement Set Up

Back Panel Connections

The following picture shows the back panel of a fully connected 473 with RS-232 cable, 19-pin measuring head cable, power cable and the Ø2 x 100 mm PRT on the 3 m cable.



6.2 External Temperature

Set Fixed External Temperature

If you do not use an external temperature sensor, you have the possibility to enter a fixed external temperature. Set the parameter so that **External Temp** shows on one data line (see section 0). If no temperature sensor is installed, the data line will not show any reading. Touch the **External Temp** data line on the screen. A window (see picture below) will appear where you can enter the desired temperature.

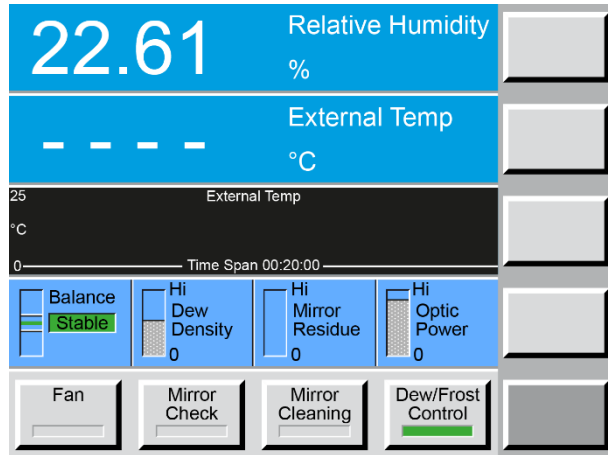

Enter the desired temperature in degrees Celsius (21 °C in this example) and activate the **Use Fixed Ext Temp** option by touching the button. When the indicator square turns green, the fixed external temperature is active.

The dialog box is titled 'Fixed External Temperature' and contains the following fields: 'Description:' with a green square and the text 'Use Fixed Ext Temp', 'Value:' with the number '0', and 'Change To:' with the number '21'. At the bottom are 'Ok' and 'Cancel' buttons.

The External Temp data line (and the graph, if shown) will now say “(fixed)”. As shown in the image on the right, the external temperature will immediately change to the temperature that was entered, and will remain there until it is changed again.

If you want to start using an external temperature probe, go to **the Fixed External Temperature** window and press the **Use Fixed Ext Temp** to disable the fixed external temperature function. The green square will turn grey.

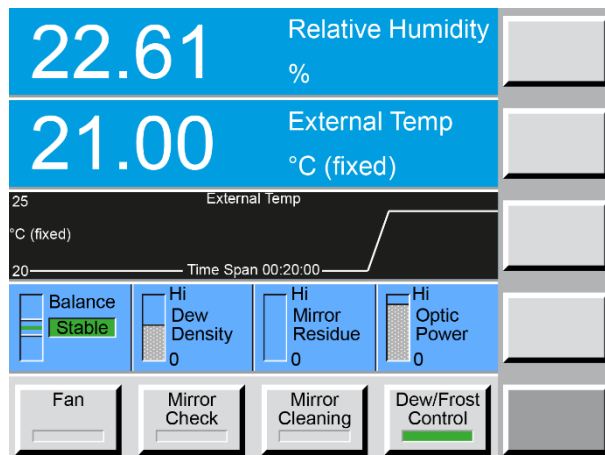

6.3 Application Integration

The 473 is suitable for many applications over the humidity and temperature ranges detailed in Section 9 'Specifications'. When installing the measuring head into a system, the operating temperature of the measuring head and the mirror cooling capacity must be carefully considered. A high measuring head temperature will limit the lowest frost/dew point that can be reached; from a head temperature of 20 °C, the mirror cooling capacity is approximately 50 °C. This means that the lowest frost point with a head temperature of 20 °C will be approximately -30 °C. If the mirror cooling is at its maximum capacity but cannot cool the mirror to at least a few degrees below the dew/frost point, the dew point or head temperature will display a constant value above the actual dew/frost point and the Dew Density on the status line will remain at 0 (zero).

Since the principle of dew point measurement requires the mirror to be cooled to a temperature where condensation forms, the transfer of heat is important in order to attain the best measurement capability. If the body of the measuring head is in contact with other surfaces, these may cause additional heating or cooling which are either useful or detrimental to measurement performance, so always take time to consider the thermal properties of the measuring head and any items in its environment and their possible effects.

The following application examples are included to show some of the most common applications of the 473. In all cases, temperature effects are discussed and there may be similar implications in your system.

Climatic Chamber Validation

A widely used method for validating or calibrating the working volume of a climatic chamber is to use a chilled mirror to measure dew point temperature of the chamber environment. In combination with single or multiple point temperature measurement, %RH values can be derived. Multiple temperature measurement in a chamber is often referred to as 'mapping', and this method is described in IEC 60068.

The 473-SH2, SH3 and SHX, (SH measuring heads) are well suited for this application. The SH measuring head can be positioned anywhere within the chamber's working volume, either on a chamber shelf or directly attached to the chamber surface. Direct surface contact between the base of the measuring head and the chamber surface can be beneficial for improving heat transfer from the measuring head. Heat transfer tape or paste can be used to further improve thermal contact.

Adequate airflow through the SH measuring head is important in order to provide stable and repeatable measurements. The integrated fan in the SH measuring head can be used to provide the needed airflow through the measuring head. If necessary for your application, an extension sample tube can be added using 6mm or ¼" Swagelok fittings as shown.



At equilibrium, the water vapor pressure is assumed to be homogenous, but the user should determine this by experimentation according to the type of chamber being tested. Temperature probes should be positioned according to the need for validation. The most common arrangement is four probes in the top corners, four in the bottom corners and a single probe in the center. For larger chambers, more probes can be added so that the entire working volume is measured. This allows for the full spatial volume to be temperature mapped. By combining this temperature data with the measured dew point, %RH can also be mapped. Software such as that supplied with the MBW T12 temperature system can be used to display and record the dew point, temperature and calculated %RH values. Please contact MBW or your local supplier for more information.

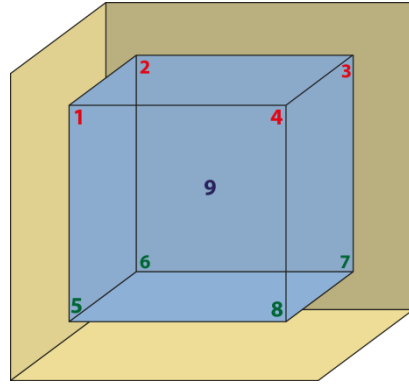

RH Generator Validation

Transportable RH Generators provide a convenient and fast way of calibrating RH instruments. Most use RH sensor control probes to measure and control the conditions in the generator's test chamber. The standard calibration uncertainty of the RH generator is limited by calibration drift, linearity and temperature coefficients of the control probe. With the use of a dew point mirror, with its inherent stability and precision, the uncertainty can be significantly improved.

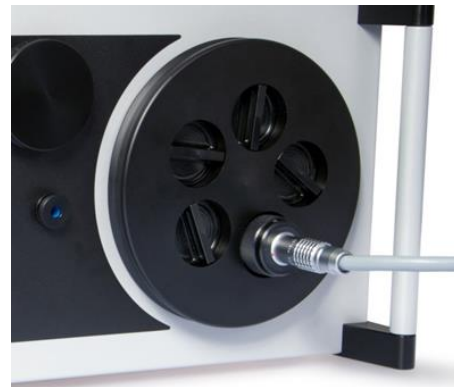

The 473-RP2 is ideal for this application. As shown, the RP2 measuring head is introduced into the generator chamber through a front access port. The measuring cell of the mirror is exposed to the moving air within the chamber and measures the temperature and humidity of the air as it passes over the measuring head. As with climatic chambers, it is assumed that, at equilibrium, water vapour pressure is homogenous throughout the chamber volume. Provided that the temperature is stable and uniform, the %RH derived from the dew point and temperature measurement is suitable for use as a transfer standard for calibration of the generator's control probe or as a reference against which units under test can be compared.

Temperature Effects

Most RH generators are also able to control temperature. This means that RH probes can be calibrated for temperature at the same time as RH, and RH calibration can be performed at working temperature. As RH is highly temperature dependent, temperature effects and gradients in particular, must be considered. With the RP2 probe installed into the RH generator chamber, the Peltier element that is used to cool the mirror causes heat to be dissipated from the body of the measuring head. This can cause temperature gradients within the generator chamber, so these effects should be evaluated and consequential uncertainty contributions applied to an uncertainty budget.



The user must therefore determine this effect experimentally for the conditions used. In the example installation shown above, the RP2 measuring head and the chamber door are thermally coupled to allow for optimum dissipation of heat generated by the measuring head. At equilibrium, the generator will establish a thermal equilibrium within the complete system so that temperature stability is optimized and gradients are minimized.

Whereas the RP2 head-mounted temperature probe (PRT) can be used for the measurement of temperature in most measurement situations, in some chamber conditions a short extension cable may be advisable to thermally 'decouple' the PRT from the measuring head. Especially at low RH conditions, where the mirror temperature can be much lower than the chamber temperature, the heating of the measuring head can cause temperature errors. Therefore, consideration of this possible effect must be included within uncertainty budgets. In calibration laboratories where the lowest possible uncertainties are required, the implementation of continuous multi-point temperature measurement allows the user to determine gradients dynamically. In such small chambers, four or six PRTs arranged around the working volume is sufficient according to IEC 60068.

When comparing (for example) RH probes to the RP2 probe mounted in an RH generator chamber, it is recommended that there is at least 10mm of clearance between the probes to minimise any thermal effects. If there is poor air movement within the chamber, separation may need to be greater than 10 mm.

In all temperature related effects recording and analysing data, understanding cause and effects, and applying best measurement practises are essential in resolving best measurement capability and low uncertainty.

Condensation

If the RP2 probe is installed through the chamber ports of an RH generator working at high temperature, a thermal gradient through the RP2 may occur and the probe may be at a slightly lower temperature than the chamber. This may cause condensation to form on the outer body of the RP2 probe. As a result, the measured dew point values will be incorrect. It is even possible that condensation on the head will cause a short circuit. To avoid such problems, make sure that the RP2 probe is inserted as far as possible into the chamber volume. More advanced RH generators feature heated doors which prevent condensation.



When measuring in a chamber where conditions are changing (ramp up phase) the thermal mass of the dew point measuring head may mean that its temperature is below the dew point in the chamber and condensation occurs. Use the 'Measuring Head Temperature' parameter of the 473 to avoid this effect.

Working or Transfer Standard

In the calibration laboratory or workshop, the 473 provides the best possible measurement capability for a working standard in controlled humidity conditions and humidity generators. By using the 473 for continuous dew point and temperature reference measurement, users can achieve small uncertainties and calibrate multiple probes in short time periods.

When an RH generator is used for on-site calibration, the combination of the RH generator, dew point mirror and temperature measurement system may not be practical for site engineers as they need to run calibrations quickly to minimize down-time. Examples of this situation include calibration of instruments used in pharmaceutical production rooms, laboratories, and critical industrial processes. In this case, the RH generator can be periodically validated using the 473 as a reference standard.

The user should define a working procedure to manage calibration traceability. Maintaining careful calibration records and history for both the transfer standard and the generator is essential to properly determine the calibration stability and drift components of uncertainty budgets. For further support, please contact MBW or your local distributor.

7 Remote Communication

The 473 is equipped with a bidirectional RS-232 communications interface which allows connection to a computer. This section provides the necessary information for the use of the interface, including the hardware connections, communications settings, and the command syntax.

7.1 Hardware Connection and Cabling

Connect a computer to the 473 using a standard *RS-232 9-pin extender cable*. The extender cable has a male connector on one end and a female connector on the other. If your computer has a 25-pin serial port connector rather than a 9-pin connector, you will also need a *25-pin to 9-pin port adapter*. Both the 9-pin RS-232 extender cable and the 25-pin to 9-pin port adapter are commonly available at most computer hardware dealers.

The 473 ignores the DSR and CTS handshaking signals. While there is no harm in connecting all 9 pins, the 473 only requires connection of three of the pins (pins 2=TXD, 3=RXD and 5=GND). For your reference, the complete connector pin-out is listed in the following table. Note that the signals identified by * are required, while the others are optional.

Signal	473 (9 pin)	Direction	Computer (9 pin)	Computer (25 pin)
	1		1	8
*TXD	2	→	2	3
*RXD	3	←	3	2
DSR	4	←	4	20
*GND	5	← →	5	7
DTR	6	→	6	6
CTS	7	←	7	4
RTS	8	→	8	5
	9		9	22

* Denotes a required connection. All others are optional.

7.2 Communication Settings

To communicate with the 473, set your computer to the following configuration:

Baud Rate:	9600
Data Bits:	8
Stop Bits:	1
Handshaking:	None

Alternatively, change the baud rate on the 473 display unit as described in section 'RS-232 Configuration' on page 42 or remotely with the commands of section 'Communication Settings' on page 54.

7.3 Command Syntax

This section details the general syntax guidelines regarding termination, leading and trailing spaces, case sensitivity, and numeric values. Throughout this section, characters originating from the computer will be shown for illustrative purposes in **this font**. Characters originating from the 473 will be shown in *this font*.

General Use

All commands require a question mark to indicate you are requesting data. When requesting data from the 473, follow the command with `?`, the question mark character. For example, the following requests the current control status.

`Control?`

The 473 will reply with the current control status (1 = on, 0 = off).

Termination Characters

All commands must be terminated with either a carriage return C_R or a carriage return linefeed combination $C_R L_F$.

Regardless of the command sent, the 473 will reply with a carriage return linefeed $C_R L_F$ at the end of the response, provided the command is recognized as valid. Here is an example:

`DP?CR` (sent by the computer to the 473)

`-10.015CRLF` (sent by the 473 back to the computer)

If the command is unrecognized, the 473 does not respond. See example below.

`Abcdef?CR` (invalid command sent from the computer)

(no response from the 473)

Leading and Trailing Spaces

The 473 ignores leading and trailing spaces. It also ignores spaces before and after equal signs and question marks. For example, both the following commands are perfectly valid.

```
Dp?cR
Dp ? cR
```

However, the following command is invalid since spaces are embedded within the keywords.

```
D p?cR
```

Case Sensitivity

All commands are insensitive to case. For example, the commands **DP?**, **Dp?**, **dP?**, and **dp?** will trigger identical responses from the 473. They will return the measured dew point value.

Numerical Values

All numerical data received from the 473 is either in standard or in scientific notation. Receiving a number as 12.34 is the same as receiving it as 1234e-2 or as 1.234e1. Depending on the value of numerical responses the 473 sends out, it may send the numbers in either standard or scientific notation.

Numeric data is never appended with text of any kind. When requesting a temperature related value, only the numeric portion of the value is sent. The units are assumed.

The following table lists the units of the numerical data that the 473 returns, regardless of the units selected on the touch screen display or set via the RS-232. When you change units (even if you change them via RS-232), you affect only what is seen on the display. All numerical values retrieved from the RS-232 will always be in the following units.

Parameter	Units via RS-232
Temperature	°C
Pressure	Pa
Flow	l/m
Volume Ratio	PPMv
Weight Ratio	PPMw

7.4 Command Reference

Below you will find a list with all available commands grouped by function. All commands are considered read-only values.

Measurement Data

<u>Syntax</u>	<u>Function</u>
DP?	Dew Point, °C
FP?	Frost Point, °C
RH?	Relative Humidity, %
RHw?	Relative Humidity (WMO), %
PPMv?	Volume Ratio, PPMv
PPMw?	Weight Ratio, PPMw
AH?	Absolute Humidity, g/m3
SH?	Specific Humidity, g/kg
VP?	Vapor Pressure, Pa
P?	Head Pressure, Pa
Tx?	External Temperature, °C
Tm?	Mirror Temperature, °C
Th?	Head Temperature, °C
Om?	Mirror PRT Resistance, Ohms
Ox?	External PRT Resistance, Ohms

System Identification

<u>Syntax</u>	<u>Function</u>
ID?	Returns a string containing instrument identification, i.e. DPM 473
IDN?	Returns only numeric portion of identifier, i.e. 473

Stability Indicators

<u>Syntax</u>	<u>Function</u>
stable?	1 = system is stable, 0 = not stable

Global Control Parameters

<u>Syntax</u>	<u>Function</u>
Pump [=i] [?]	Fan on / off / status
MirrorCheck [=i] [?]	Execute mirror check
Control [=i] [?]	D/F Mode on / off / status

Advanced Features

Force Frost Settings

<u>Syntax</u>	<u>Function</u>
<code>ForceFrost.on [=i] [?]</code>	1 activates Force Frost (FF), 0 deactivates FF
<code>ForceFrost.below [=n] [?]</code>	Temperature, under which FF activates, °C
<code>ForceFrost.coolTo [=n] [?]</code>	Temperature, to which FF cools, °C
<code>ForceFrost.holdBelow [=n] [?]</code>	Temperature, below which FF holds, °C
<code>ForceFrost.dispHold [=i] [?]</code>	Freezes frost/dew point display/output during FF
<code>SaveCfg=473</code>	Saves all configurations to 473

Preparation for Mirror Cleaning

<u>Syntax</u>	<u>Function</u>
<code>MinHeadRemovalTemp [=n] [?]</code>	Head and internal cooling are heated above this temp when cleaning mirror button is pressed prior to removal of the head, °C
<code>SaveCfg=473</code>	Saves all configurations to 473

Automatic Mirror Control

<u>Syntax</u>	<u>Function</u>
<code>AMC.on [=i] [?]</code>	1 activates AMC, 0 disables AMC
<code>AMC.cycleTime [=n] [?]</code>	AMC cycle time in minutes
<code>AMC.heatTime [=n] [?]</code>	AMC heating, hold time in minutes
<code>AMC.temp [=n] [?]</code>	Target temperature during AMC, °C
<code>AMC.dispHold [=i] [?]</code>	=1 enables frost/dew point output hold during AMC
<code>SaveCfg=473</code>	Saves all configurations to 473

Fan Control Parameters (SH2, SHX only)

<u>Syntax</u>	<u>Function</u>
<code>Pump [=i] [?]</code>	Fan on / off / status
<code>Pump.dutyCycle [=n] [?]</code>	Fan power in %, 20...100
<code>SaveCfg=473</code>	Saves all configurations to 473

External Temperature Calibration Coefficients

<u>Syntax</u>	<u>Function</u>
<code>ExtTempCal.r0 [=n] [?]</code>	Callendar VanDusen R0 coefficient, ~ 100.00
<code>ExtTempCal.a [=n] [?]</code>	Callendar VanDusen A coefficient, ~ 3.9083e-3
<code>ExtTempCal.b [=n] [?]</code>	Callendar VanDusen B coefficient, ~ -5.775e-7
<code>ExtTempCal.c [=n] [?]</code>	Callendar VanDusen C coefficient, ~ -4.183e-12
<code>ExtTempCal.avg [=n] [?]</code>	Amount of averaging applied to measurement, ~40
<code>ExtTempCal.avgBand [=i] [?]</code>	Only average when measurements remain within this band, ~ 0.2 °C
<code>SaveCal=473</code>	Save these and other calibration parameters

Mirror Temperature Calibration Coefficients

Syntax	Function
<code>MirrorTempCal.r0 [=n] [?]</code>	Callendar VanDusen R0 coefficient, ~ 100.00
<code>MirrorTempCal.a [=n] [?]</code>	Callendar VanDusen A coefficient, ~ 3.9083e-3
<code>MirrorTempCal.b [=n] [?]</code>	Callendar VanDusen B coefficient, ~ -5.775e-7
<code>MirrorTempCal.c [=n] [?]</code>	Callendar VanDusen C coefficient, ~ -4.183e-12
<code>MirrorTempCal.avg [=n] [?]</code>	Amount of averaging applied to measurement, ~40
<code>MirrorTempCal.avgBand [=i] [?]</code>	Only average when measurements remain within this band, ~ 0.2 °C
<code>SaveCal=473</code>	Save these and other calibration parameters

Analog Output (optional)

Syntax	Function
<code>Ana1.param [=i] [?]</code>	Parameter configuration for analogue output 1
<code>Ana1.paramMin [=n] [?]</code>	Min. Value
<code>Ana1.paramMax [=n] [?]</code>	Max. Value
<code>Ana1.OutMin [=n] [?]</code>	Min. Voltage (-10V)
<code>Ana1.OutMax [=n] [?]</code>	Max. Voltage (+10V)
<code>Ana1.calGain [=n] [?]</code>	Gain scaling factor for DAC
<code>Ana1.calZero [=n] [?]</code>	Zero scaling factor for DAC
<code>Ana1.output = n</code>	Requires to set the analog output when the DAC converter is calibrated. Automatically sets to <code>Ana1.hold = 1</code> If calibration done, <code>Ana1.hold</code> must be sent = 0.
<code>Ana1.hold [=i] [?]</code>	1 calibration mode. Analog output is set with the command <code>Ana1.output = n</code> 0 normal mode. Analog output the parameters monitored set with <code>Ana1.param = i</code>
<code>SaveCfg=473</code>	Saves all configurations to 473
<code>Ana2.param [=i] [?]</code>	Parameter configuration for analogue output 2
<code>Ana2.paramMin [=n] [?]</code>	Min. Value
<code>Ana2.paramMax [=n] [?]</code>	Max. Value
<code>Ana2.OutMin [=n] [?]</code>	Min. Voltage (-10V)
<code>Ana2.OutMax [=n] [?]</code>	Max. Voltage (+10V)
<code>Ana2.calGain [=n] [?]</code>	Gain scaling factor for DAC
<code>Ana2.calZero [=n] [?]</code>	Zero scaling factor for DAC
<code>Ana2.output = n</code>	Requires to set the analog output when the DAC converter is calibrated. Automatically sets to <code>Ana1.hold = 1</code> If calibration done, <code>Ana1.hold</code> must be sent = 0.
<code>Ana2.hold [=i] [?]</code>	1 calibration mode. Analog output is set with the command <code>Ana1.output = n</code> 0 normal mode. Analog output the parameters monitored set with <code>Ana1.param = i</code>
<code>SaveCfg=473</code>	Saves all configurations to 473

Communication Settings

Syntax	Function
<code>Baud [=n] [?]</code>	Set Baud Rate: 1200, 2400, 4800, 9600, 19200, 38400, 57600, 115200. (Default rate is 9600)
<code>SaveCfg=473</code>	Saves all configurations to 473

8 Maintenance

8.1 Calibrate the Touch Screen

Before using the instrument for the first time, or when the instrument is used by different operators, you may need to calibrate the touch screen to your finger positioning preference. Left and right handed people, for example, may have different points of pressure when using the touch screen.

To calibrate the touch screen:

Press and hold the **Enter** key on the numerical keypad for 3 to 4 seconds. You will hear two short beeps and the key in the upper right corner will turn yellow.

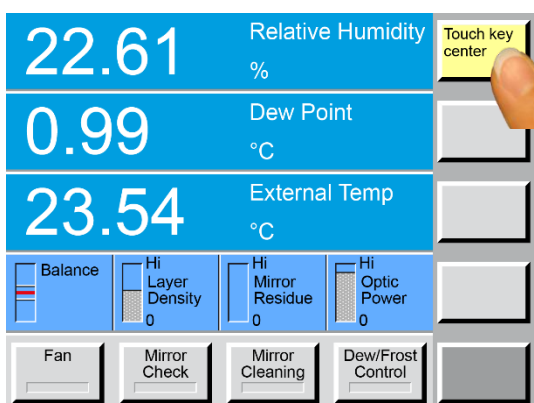

With the tip of your finger, press the center of the yellow key in the upper right-hand corner of the touch screen. The key will turn grey and another key will turn yellow.

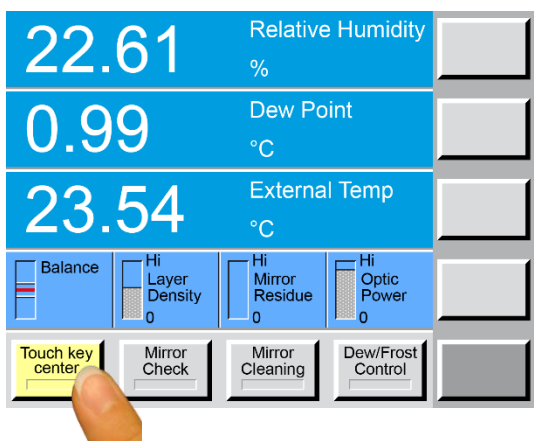

Now touch the yellow key in the lower left-hand corner of the touch screen. The key will turn grey and you have successfully calibrated the touch screen.

Test your new touch screen calibration by pressing the bottom right menu selection key several times. If it does not work to your satisfaction, repeat the calibration.

8.2 Mirror Cleaning

At the heart of the 473 is the measuring head assembly. It is highly sensitive and accurate, yet easily accessible for periodic mirror cleaning. To ensure high accuracy, the mirror should be cleaned before starting a measurement. Inspect the mirror carefully. Use a magnifying glass, if necessary. If there are signs of contamination or if you suspect that contamination is present, use the following procedure to clean the mirror.

SH2 / SH3 / SHX Measuring Head

To access the mirror and the opto-electronic components, remove the measuring head cover.

The cover looks like a large, tan-colored knurled knob. To remove it, simply turn it counterclockwise. It requires approximately three full turns to completely unscrew it.



Once the screw cover has been removed, remove the black optical module by pulling it straight towards you. The loose half is the optical module containing the light emitting and light sensing opto-electronic elements and the gold contacts. The other half contains the mirror, temperature sensor, and some mating gold contacts. Avoid touching the mirror and gold contacts with your fingers to prevent contamination.



Clean the mirror with a clean cotton swab or a lint free tissue.



Never attempt to polish the mirror.

If necessary clean the mirror with methanol or similar alcohol. Then clean the mirror with distilled water to ensure the cleaning chemicals are completely removed from the mirror surface.



RP2 Measuring Head

To access the mirror and the opto-electronic components, remove the optical assembly from the measuring head. The two red dots indicate where the measuring head and optical assembly will separate. When reassembling the measuring head after cleaning make sure the two red dots align as shown in the picture.



To remove the optical module, pull the two halves of the measuring head apart. The loose half is the optical module containing the light emitting and light sensing opto-electronic elements and gold contacts. The other half contains the mirror, temperature sensor, and some mating gold contacts. Avoid touching the mirror and gold contacts with your fingers to prevent contamination.



Clean the mirror with a clean cotton swab or a lint free tissue.



Never attempt to polish the mirror.

If necessary, clean the mirror with methanol or alcohol. Then clean the mirror with distilled water to ensure the cleaning chemicals are completely removed from the mirror surface.



8.3 Exterior Cleaning

Front Panel

The 473 front panel is completely sealed and can easily be cleaned with liquid glass cleaner or other mild cleaning chemicals applied to a cloth. Clean the front panel periodically as needed.

8.4 Peltier Cooling Test

The Peltier module used for mirror cooling and heating can age over time. It can also lose performance when used at its limits. If you think the measuring head is not cooling down fast enough during measurement, you can check this with the Peltier Cooling Test (PCT) function.

Please follow the instructions in section 'Peltier Cooling Test' on page 41.

8.5 Periodic Maintenance Checks

Apart from periodic mirror cleaning, the 473 requires very little maintenance, but the following checks are recommended to maintain the optimal instrument performance:

- Check and clean the fan
- Check the condition of power, RS-232 and other external cables and connectors
- Check the condition of connections

9 Error Messages

9.1 Reversible Error Messages

Error Message	Explanation	Possible Reasons and Solutions
<i>Peltier current limit exceeded: %g Amp.</i>	Peltier Feedback shows higher current than allowed %g Amp. = measured current value on the Peltier	<ul style="list-style-type: none"> - Indicates a problem with the Peltier driver or a control problem - Try again after several minutes, if it fails again, contact MBW service
<i>Mirror temp limit exceeded</i>	Mirror temperature is too high	<ul style="list-style-type: none"> - Chamber temperature may be too high. - Try again after several minutes, if it fails again, contact MBW service

9.2 Irreversible Error Messages

Error Message	Explanation	Possible Reasons and Solutions
<i>ERROR: Temperature measurement system is not responding.</i>	Hardware failure	<ul style="list-style-type: none"> - Contact MBW service or its duly authorized representatives
<i>ERROR: Optic measurement system is not responding</i>	Hardware failure	<ul style="list-style-type: none"> - Contact MBW service or its duly authorized representatives
<i>ERROR: Analog measurement system is not responding.</i>	Hardware failure	<ul style="list-style-type: none"> - Contact MBW service or its duly authorized representatives
<i>DAQ Unit</i>	Hardware failure	<ul style="list-style-type: none"> - Contact MBW service or its duly authorized representatives

9.3 Fan failure SHX

Error Message	Explanation	Possible Reasons and Solutions
<i>Fan not found</i>	The display unit does not recognize a fan	<ul style="list-style-type: none">- No fan is mounted to the measuring head- There is a cable break between the display unit and the fan. Contact MBW service
<i>Fan supply failure</i>	The fan driver in the display unit detects that the supply voltage of the fan is missing/is too low	<ul style="list-style-type: none">- A blown fuse on the fan driver PCB. Contact MBW service

10 Specifications

Specifications	473-RP2 *	473-SH2	473-SHX	473-SH3
Measuring Ranges				
Frost/Dew Point	-20...70 °C	-20...70 °C	-30...99 °C	-50...70 °C **
Relative humidity	5...100 %rh	5...100 %rh	5...100 %rh	n/a
Temperature (head mount PRT)	-20...80 °C	-20...80 °C	-20...125 °C	n/a
Temperature (cable mount PRT)	-50...100 °C	-50...100 °C	-50...150 °C	n/a
Accuracy				
Frost/Dew point	≤ ± 0.15 °C	≤ ± 0.1 °C	≤ ± 0.1 °C	≤ ± 0.1 °C
Temperature	≤ ± 0.07 °C	≤ ± 0.07 °C	≤ ± 0.07 °C	≤ ± 0.07 °C
Reproducibility				
Frost/Dew point	≤ ± 0.07 °C	≤ ± 0.05 °C	≤ ± 0.05 °C	≤ ± 0.05 °C
Temperature	≤ ± 0.05 °C	≤ ± 0.05 °C	≤ ± 0.03 °C	≤ ± 0.05 °C
Standard Features				
External temperature probe	Ø3 x 30 mm PRT, 0.5 m cable	Ø2 x 100 mm PRT, 0.5 and 3 m cables	Ø3 x 30 mm PRT, 1 m cable	No external temperature probe
Transport case	Custom fit foam-lined Peli 1550			Cardboard box
Gas connections	None	6 mm or ¼" Swagelok		
Digital I/O	RS-232			
Display	5.7" LCD with color touch screen			
Mirror temperature sensor	Platinum Resistance Thermometer (IEC 60751:2008)			
Power cable	2.5 m			
Operating instructions	English			
Calibration certificate	Factory calibration: 5 points FP/DP, 3 points temperature			
Optional				
Internal barometric pressure sensor	0.1% or 0.01% accuracy, 700...1200 mbar			
Analog outputs	Two user programmable, -10...+10 V and 4...20 mA			
Calibration upgrade	Upgrade to SCS accredited ISO 17025 calibration			
Additional Information				
Power supply	100...120 VAC / 200...240 VAC, 50/60 Hz, 100 Watt (auto switching)			
Operating conditions:				
Instrument	0...40 °C, 90 %RH non-condensing			
Measuring heads RP2, SH2, SH3	-50...80 °C, 99 %RH non-condensing			
Measuring head SHX	-40...125 °C, 99 %RH non-condensing			
Storage conditions	-20...50 °C			
Weight & Dimensions	Instrument only		In Transport Case	
Dimensions	W310 x H176 x D284 mm		W510 x H220 x D450 mm	
Weight	5 kg		12 kg	
Protection	IP20		IP65	

We reserve the right to change design or technical data without notice.

* The RP2 measuring head is only suitable for use in applications with moving air.

** To reach the lower measuring range limit of -50 °C FP the ambient temperature must not be above 23 °C.

11 Drawings

11.1 Display Unit

Side View

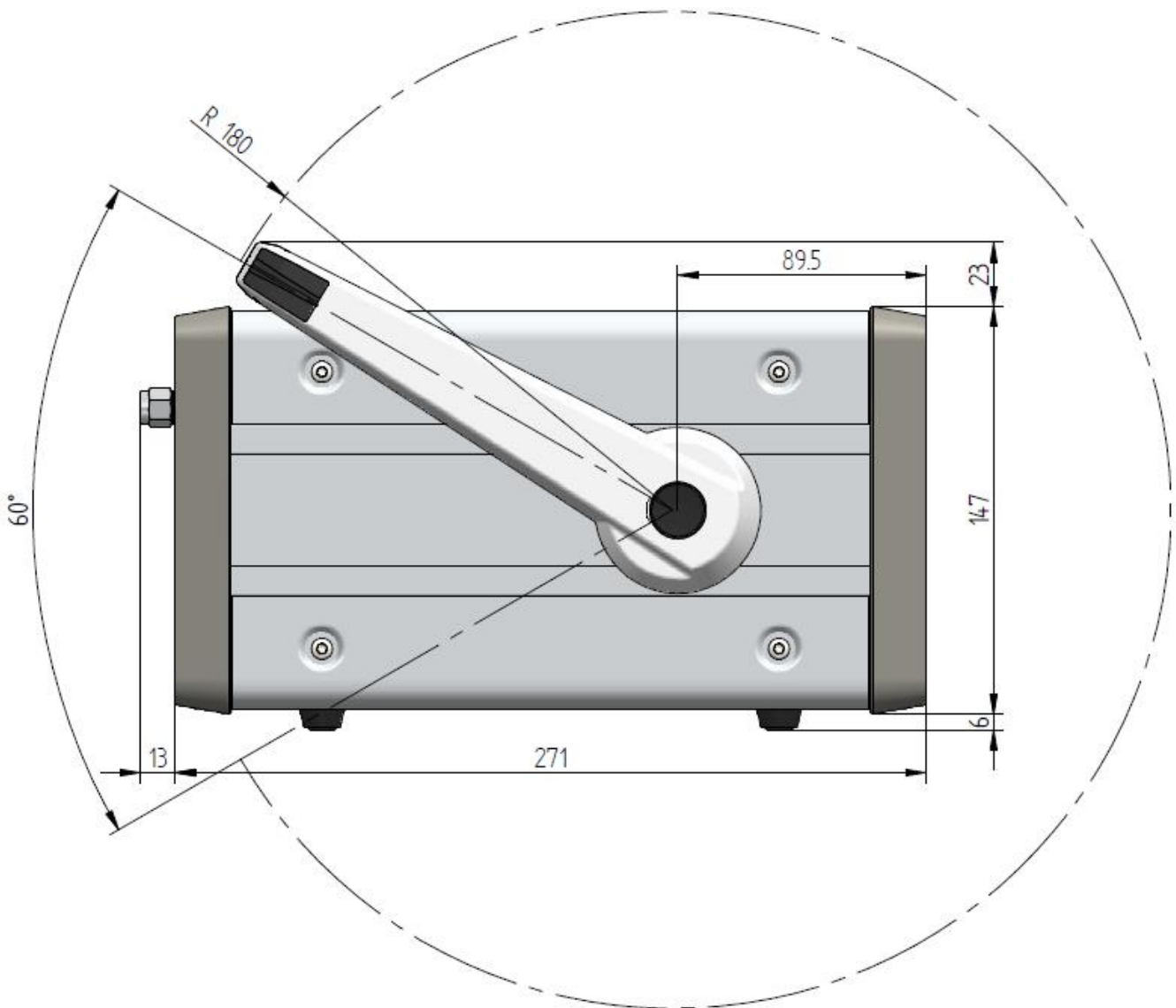

Front View



Back View



11.2 Measuring Heads

RP2

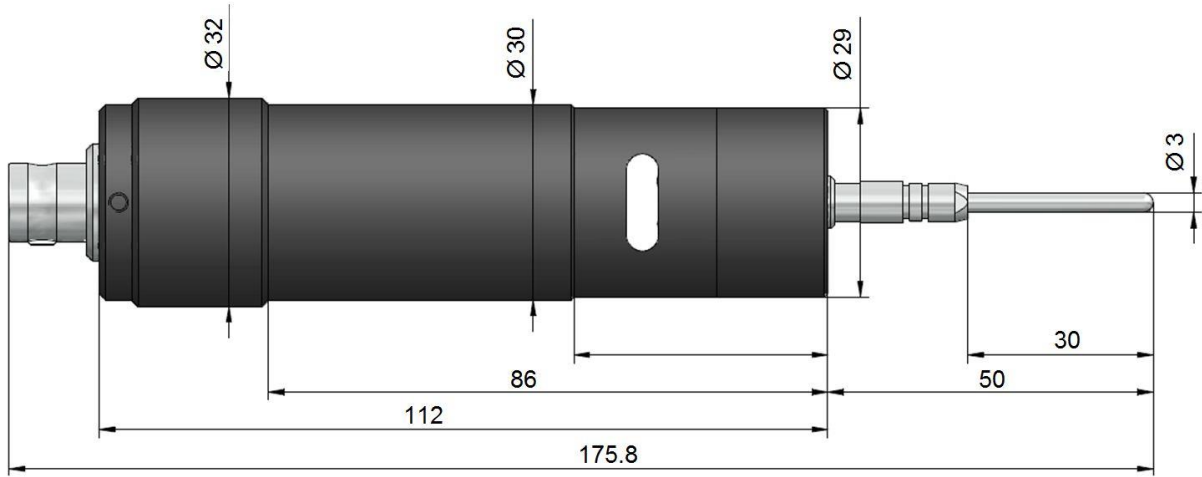

SH2

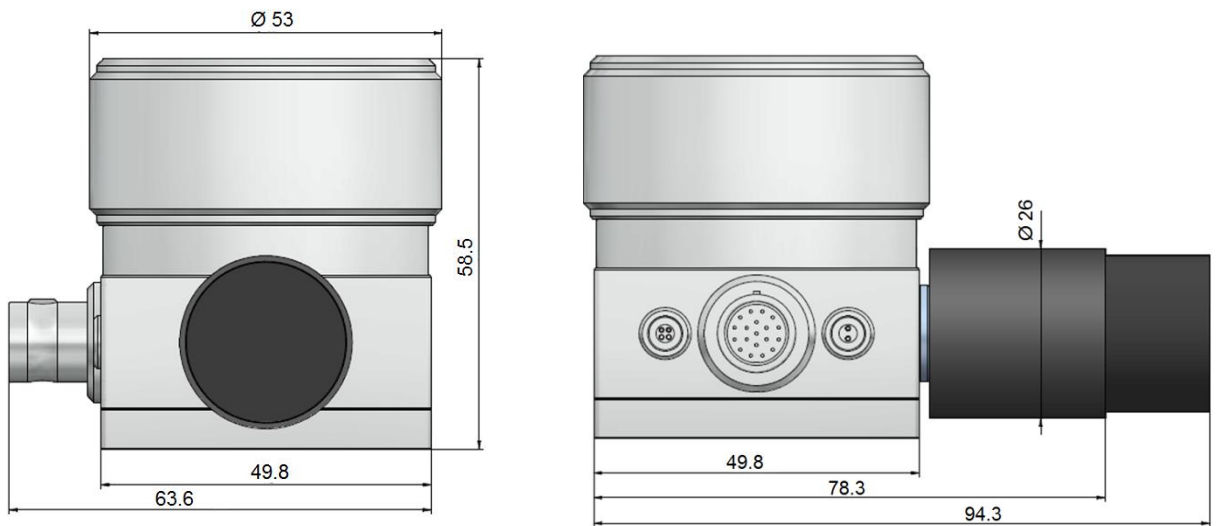

SHX

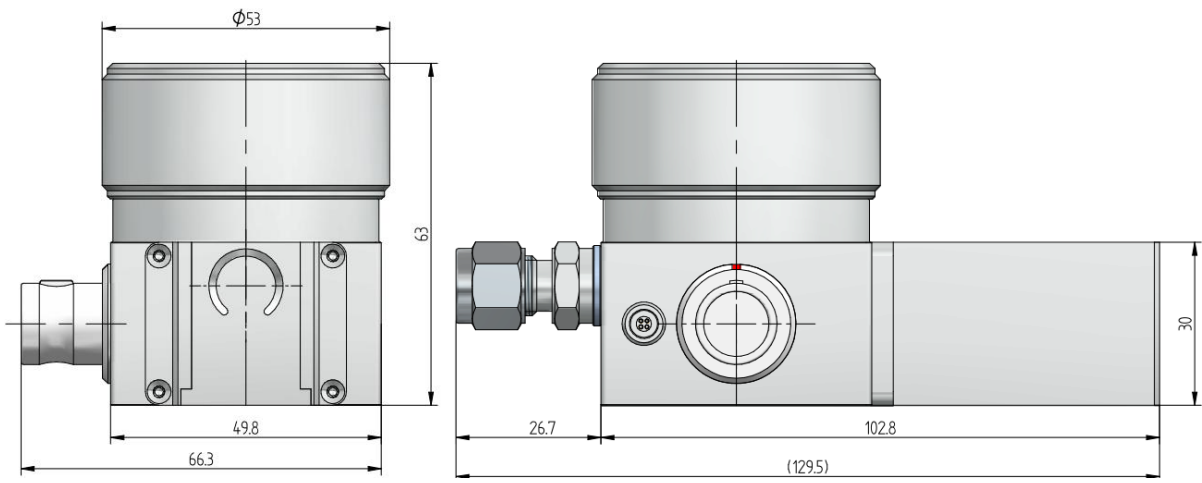

SH3

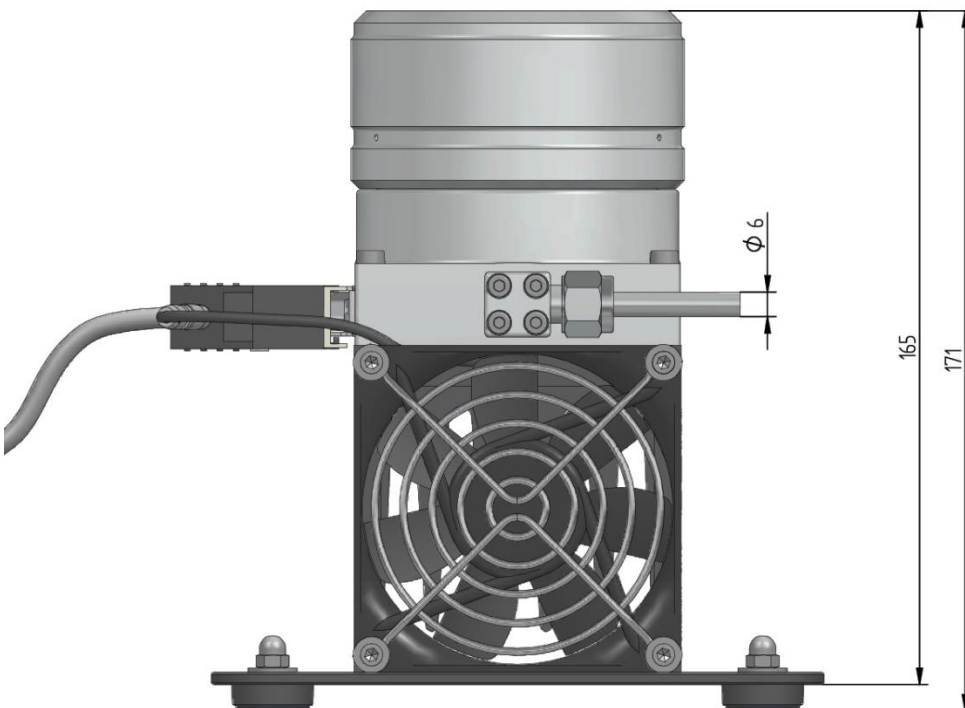

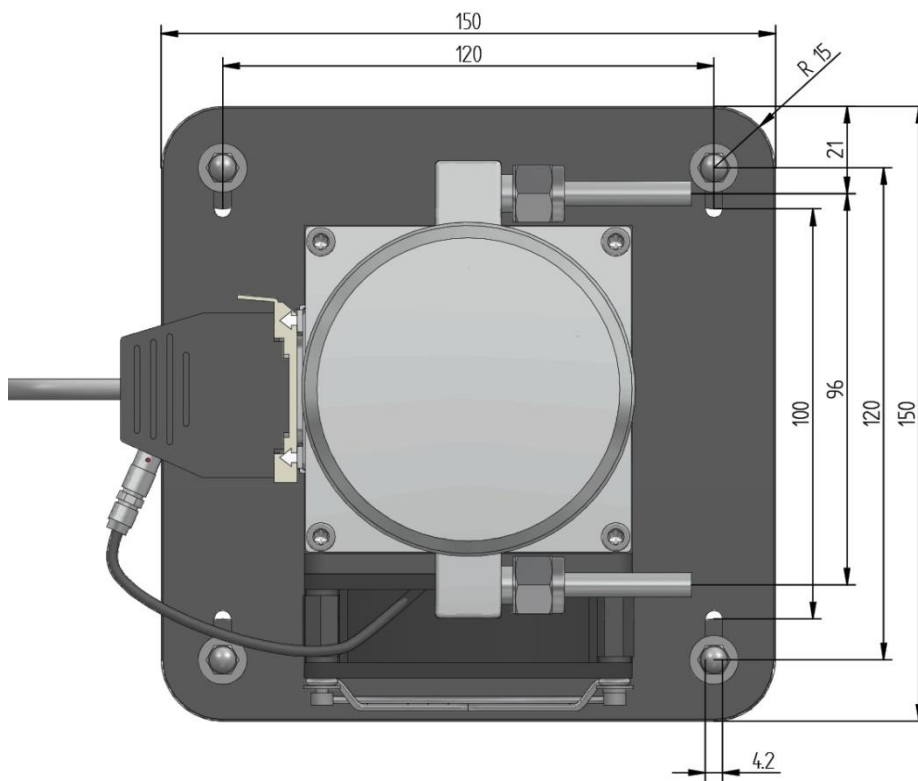
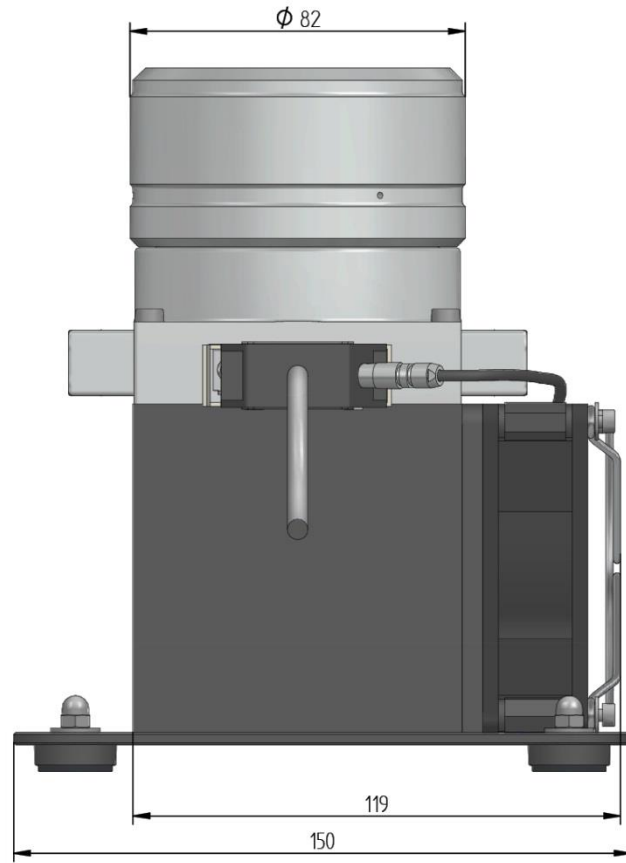

12 FAQ's

Problem: The touch screen does not respond or detects inputs in the wrong position.

Solution: *Try a touch screen calibration, as described in chapter 8.1 'Calibrate the Touch Screen' on page 55.*

Problem: The device was set up with an unknown baud rate or the displayed colors were configured looking like a candy shop. What is the fastest way to go back to a default setup?

Solution: *Press and hold key number 9 on the keyboard for 3-4 seconds. Confirm the message by pressing Ok.*

Problem: The display was configured incorrectly and I would like to go back to factory default.

Solution: *Press and hold key number 7 or 8 on the keyboard for 3-4 seconds. This enables you to restore the factory default setup.*

Problem: The 473 does not show the relative humidity (RH) value on its display.

Solution: *Make sure a PRT is connected either to the back of the 473 or directly to the measuring head.*

Problem: Pressing Dew/Frost Control does not activate mirror cooling.

Solution A: *Check the optical module is correctly fitted.*

Solution B: *Check the optical condition by observing the optic power indicator in the status line. If the optical components are faulty, dew/frost control will not start. Please contact MBW or your local supplier for advice.*